

Application of Combined Space and Water Heat Pump Systems To Existing Homes for Efficiency and Demand Response

Final Report

Bonneville Power Administration
Technology Innovation Project 338

Organization

Washington State University –
WSU Energy Program in Olympia, WA

Co-Sponsors

Benton Rural Electric Association
The Energy Trust of Oregon
Inland Power and Light Mitsubishi Electric
Northwest Energy Efficiency Alliance
Pacific Gas & Electric
Pacific Northwest National Laboratory
Puget Sound Energy
Sanden International USA
Tacoma Public Utilities

Prepared by

Ken Eklund and Adria Banks, WSU Energy Program
360-956-2019, eklundk@energy.wsu.edu



Energy Program

WASHINGTON STATE UNIVERSITY

Publication Date: September 30, 2017

WSUEEP17-004

Contents

A Technology Innovation Project Report	iv
Acknowledgements.....	iv
Abstract.....	iv
Executive Summary	1
Introduction.....	2
Field Study.....	3
Sanden Split System	3
Mitsubishi Ductless Heat Pump Plus Water Heater.....	3
Sanden Eco Runo System	3
Description	3
Site Selection.....	3
Code Issues and Solutions.....	3
System Design and Installation.....	4
Challenges in Monitoring.....	6
Field Study Details.....	7
Site Summaries	7
Monitoring Setup	7
Field Study Data Analyses	10
Domestic Hot Water	10
Space Heat	10
Overall System Efficiencies	11
Space and Water Heating Efficiencies	11
Field Study Results.....	12
Water Heating Insights: Impact of Hot Water Volume on Performance.....	19
Eco Runo Cold Weather Space Heating Performance	21
Study of Combined Systems Retrofitted into Manufactured Homes	25
Conclusion	27
Recommendations	28
Ongoing Work.....	28
References.....	29
Appendix A: Laboratory Assessment	1
Appendix B: Pacific Northwest National Laboratory Report	1
Appendix C: Climate-Destroying Refrigerants.....	1

Tables

Table 1. Heating Zones of Test Sites	7
Table 2. CO ₂ Test Site Characteristics	7
Table 3. DHP+ Test Site Characteristics	7
Table 4. Data from Monitoring Showing Temperatures, Water Used, and Days Monitored*	18
Table 5. Conditioned Floor Area, Heat Loss Rate, and System Power Use.....	18
Table 6. Comparison of Annual kWh for Space and Water Heat per Square Foot of CFA*	19
Table 7. Comparable Field Test Values	20
Table 8. Lab Space Heat Test Values.....	24

Figures

Figure 1. Schematic of the CO ₂ Split System.....	5
Figure 2. Schematic of the DHP+ Water Heating System	5
Figure 3. Simplified Schematic of Eco Runo System	6
Figure 4. Onset Monitoring Configuration for a Typical Split System.....	9
Figure 5. Field Monitoring Setup for Eco Runo Sites in McCall, Idaho	9
Figure 6. System Based on an X-Block	12
Figure 7. Basic FAF Conversion Layout.....	13
Figure 8. Weekly Field Energy Factor by OAT at the California Sites.....	14
Figure 9. Average Daily Source, Heated, and Tempered Water Temperatures	14
Figure 10. Average Daily OAT and IAT	15
Figure 11. Daily Average Hot Water Use at the California Sites	16
Figure 12. OAT with Daily Average and Maximum and Minimum	17
Figure 13. Daily Flow and Energy Use.....	19
Figure 15. System Annual COP in Oversupply vs Number of Occupants – Portland Climate	20
Figure 16. OAT Measured at McCall Eco Runo Sites: Installation through May 2017	22
Figure 17. Average Daily Indoor and Exterior Temperatures for Study Period	22
Figure 18. DHW Temperatures at McCall Sites during Cold Weather Heating Test	23
Figure 19. Daily Average Field Energy Factor – Space Heating plus DHW Preheating	24
Figure 20. Lab Home A System Schematic.....	25

Abbreviations

AC	alternating current
ASHRAE	American Society of Heating, Refrigerating and Air-Conditioning Engineers
BPA	Bonneville Power Administration
Btu	British thermal unit
CO ₂	carbon dioxide
COP	coefficient of performance
DOE	U.S. Department of Energy
DHW	domestic hot water
DR	demand response
EF	energy factor
ER	electric resistance
FEF	Field Energy Factor
GPD	gallon per day
GPM	gallons per minute
GWP	Global Warming Potential
HFC	hydrofluorocarbons
HPWH	heat pump water heater
HSPF	Heating Seasonal Performance Factor
kWh	kilowatt hour
NEEA	Northwest Energy Efficiency Alliance
NSH	NEEA's Next Step Home Program
OAT	outside air temperatures
PNNL	Pacific Northwest National Laboratory
PSI	pound per square inch
SEEM	Simple Energy and Enthalpy Model
TIP	Technology Innovation Program
UL	Underwriters Laboratory
WSU	Washington State University
XPB	Heat Exchange Pump Block

A Technology Innovation Project Report

The research described in this report was co-funded by Bonneville Power Administration (BPA) through their Technical Innovation Office to:

- Assess the potential for emerging technologies, and
- Provide for development of those technologies to increase the efficiency of electricity use and provide other benefits, such as capacity reduction and demand response services.

BPA is undertaking a multi-year effort to identify, assess, and develop emerging technologies with significant potential for contributing to the goals of efficiency, capacity reduction, demand response, and climate change remediation.

Neither Washington State University (WSU) nor BPA endorse specific products or manufacturers. Any mention of a particular product or manufacturer should not be construed as an implied endorsement. The information, statements, representations, graphs, and data presented in this report are provided as a public service. For more reports and background on BPA's efforts to "fill the pipeline" with emerging, energy-efficient technologies, visit the Energy Efficiency's Emerging Technology (E3T) website at http://www.bpa.gov/energy/n/emerging_technology/.

Ken Eklund is the Building Science and Standards Team Lead for the WSU Energy Program. His background includes research organization and management spanning 40 years in the energy-efficiency field. His work at WSU includes facilitating and coordinating staff involved in building science research, and developing and implementing research projects like the current one, which leverages the experience and capabilities of WSU staff and of skilled subcontractors – all blended into a collaborative team.

Acknowledgements

This project was greatly helped by the management of Janice Peterson, Project Manager, and James Hillegas-Elting, COTR. WSU staff David Hales, monitoring expert; Adria Banks, analyst; and Melinda Spencer, technical editor, were key to the project success, together with Ecotope's Ben Larson. Mr. Larson managed the G3 and Eco Runo lab tests at Cascade Engineering Services, and analyzed and reported the data. Special thanks to Mark Jerome of CLEAResult who is the guiding light at all system installations. Thanks also to the utility partner representatives: Eric Miller, Benton Rural Electric Association; David Shepherd-Gaw, Cowlitz PUD; Fred Gordon, the Energy Trust of Oregon (ETO); Lindsey Hobbs and Todd Williams, Inland Power and Light; Rem Husted, PSE; and Bruce Carter and Rich Arneson, Tacoma Power. And great appreciation goes to Charlie Stephens at NEEA, and to Dave Kresta, the father of the DHP+. Thanks also to John Miles of Sanden USA (Sanden), Albert Rooks, head of the local distributor Small Planet Solutions, and Dave Sweet of Taco Comfort Solutions for their engagement and expertise, and to Cheryn Metzger of the Pacific Northwest National Laboratory (PNNL) for leading its experiments.

Abstract

Three types of heat pumps are the subject of this research: second-generation CO₂ refrigerant split system heat pump water heaters (HPWHs) (split system); a larger capacity CO₂ refrigerant system designed specifically for space heating (Eco Runo) manufactured by Sanden; and a conventional refrigerant ductless heat pump (DHP) with water heater (DHP+) manufactured by Mitsubishi. The research focused on performance in existing homes including research at the PNNL Lab Homes Test Center for energy and demand response (DR) performance.

Executive Summary

This report was prepared for Technology Innovation Project (TIP) 338 conducted by Washington State University (WSU) Energy Program and co-funded by Bonneville Power Administration (BPA). The research expanded the search for a combined space and water heater for existing homes and to three different heat pump systems. The equipment to be tested in this study is manufactured by Sanden and by Mitsubishi Electric. Three types of heat pumps are studied in this research:

- Sanden CO₂ refrigerant split system heat pump water heaters (HPWHs) (split system) operating in retrofit contexts,
- A larger capacity CO₂ refrigerant system designed specifically for space heating (Eco Runo) manufactured by Sanden, and
- A conventional refrigerant ductless heat pump (DHP) with water heater (DHP+) manufactured by Mitsubishi.

The scope of this project is vast. It originally focused on the split system and DHP+; the Eco Runo was added later when it was made available by Sanden. If all systems could be fully tested and documented, a comprehensive strategy for combined space and water heating for all climates and levels of housing efficiency would be available. Unfortunately, this was not possible during the two years of the project.

The project was plagued by delays that limited its findings. The most significant was Mitsubishi's inability to deliver DHP+ prototypes for field testing during the project term. This part of the project may continue since it is funded primarily by BPA. The Eco Runo delivery was slow, causing delay in the lab test and field installations. Lack of collaboration by building officials caused the loss of three sites and delays in obtaining permits at other locations. The main findings of this research are:

- The split system can provide year-round space and water heating in a mid-efficiency existing home in Olympia, WA, during a very cold winter (2016-2017).
- The Sanden Generation 3 split system heat pump (G3) lab test showed efficiency comparable to the original split system while providing settable output temperatures and solving the defrost issue.
- The Pacific Northwest National Laboratory (PNNL) Lab Homes test showed that a split system could deliver space heat through a forced air furnace (FAF) conversion, meet combined space and water heating settings in low-efficiency homes (R11 walls, R19 roof, and U.68 windows) down to 40°F outdoor temperature, and that demand response (DR) capacity creation did not negatively impact space or hot water temperatures down to 25°F outdoor temperature. The implications for small homes built to current energy codes are that this technology can provide space and hot water with DR benefits in climate areas with design temperatures as low as 25°F with a minimum of backup heat.
- The Eco Runo lab test showed the equipment was electrically and mechanically safe and functional, and that it could operate as a source of heat for space and hot water.
- In February 2017, the Eco Runo was installed in two homes in McCall, Idaho, sites where the split system failed in a previous research project, TIP 326 (Eklund and Banks, 2016). The systems experienced temperatures as low as 10°F and provided space and hot water successfully during the end of winter and spring 2017.

Introduction

This is the final report on the WSU Energy Program research into the performance of CO₂ refrigerant heat pumps used for combined space and water heating in existing homes. The research was co-funded by BPA through its Technology Innovation Program (TIP). The equipment tested in this study was manufactured by Sanden International in Australia and Japan.

This project expanded the combined system concept from split system prototypes in high efficiency new homes to new technologies and existing homes of various efficiencies. It was proposed to conduct field tests of the Sanden split system at five site-built field sites ranging from Spokane to Northern California, as well as at the PNNL Lab Homes facility to assess the ability of the technology to serve different space heat and hot water loads, and to provide DR services.

One of these sites was fitted with Sanden's G3 system, which was lab tested during TIP 338. The project also included the new concept of adding water heating to a DHP and testing it at five sites. This is called the DHP+ and is being developed by Mitsubishi. Shortly after the project launched, Sanden offered the Eco Runo as a possible solution for higher-load and efficient homes in colder climates. A lab test was funded by BPA and the Northwest Energy Efficiency Alliance (NEEA). Unfortunately, the unit to be tested did not arrive until October 2016, and the field test units were not delivered until February 2017, causing the information gleaned about this product during the last project year to be limited.

The project succeeded in:

- Establishing baseline space and domestic hot water (DHW) use patterns for a number of sites.
- Installing and monitoring three different configurations of split system, combined systems in retrofit applications in four different climate zones.
- Conducting lab tests on the Eco Runo and collaborating on a lab test for the G3 split system.
- Developing and testing several different configurations for a combined system based on the Eco Runo.

The region desperately needs a natural refrigerant solution for space and water heating. Every heat pump or HPWH installed with climate-destroying refrigerants is a step in the wrong direction (described further in Appendix C). A solid set of natural refrigerant solutions must be developed and implemented. This research is a small but important step in this direction.

Field Study

Sanden Split System

The project was designed to test the Sanden split system HPWH as a combined space and water heating system in a number of retrofit situations, including single-family homes with different levels of thermal efficiency located in different climates, and a controlled cold weather experiment in the least-efficient homes in the study at the PNNL Lab Homes Test Center. The system was developed in TIP 326 using off-the-shelf components. The two single-family sites located in Northern California had different combined system designs from the other sites.

Mitsubishi Ductless Heat Pump Plus Water Heater

This element of the original project design was a joint project with NEEA to field test a market-ready prototype at five sites located in all three of the region's heating climate zones corresponding to International Energy Conservation Code Zones 4C, 5, and 6. The sites were recruited and monitoring installed to collect baseline data early in the first project year. The project was delayed due to loss of the tank supplier and attempts to locate a replacement. If this portion of the project does proceed, the results will be available after this report is published; thus, the results are not covered in this report.

Sanden Eco Runo System

The Final Report for TIP 326 identified the need for a higher-capacity CO₂ heat pump as a solution for efficient homes in cold climates or higher-load homes in other climates. When the proposal for TIP 338 was written and funded, the larger-capacity CO₂ heat pump was not available or mentioned as part of the project. The technology was offered by Sanden in early 2016.

Two Eco Runo systems were installed by WSU with NEEA support in McCall, Idaho at the TIP 326 sites in February 2017. The installation at two additional sites, where the Eco Runo was substituted for a split system, were eliminated from this research by actions of local and state officials.

Description

Site Selection

The goal for site selection was to identify sites quickly, install monitoring equipment to establish baseline space and water heating use, and then install the heat pump with expanded monitoring. At some sites, a third stage was to be added of weatherizing the house after the system was installed.

The sites with the split system were originally located in Olympia, Kalama, and Spokane, Washington; Portland, Oregon; and Grass Valley and Nevada City, California. The hosting utilities were PSE, Cowlitz PUD, Inland Power, ETO (representing Portland General Electric) and Pacific Gas and Electric (PG&E). The Eco Runo was substituted for the split system at the sites in Kalama and Spokane when it became available. A site in Tacoma was substituted for the Kalama site and Tacoma Power substituted as host for Cowlitz PUD.

Code Issues and Solutions

The CO₂ HPWHs used in these experiments were not yet UL listed, except for the G3 split system installed at the Portland site. Electrical and building permits were obtained for each installation. The situation was complicated by the fact that the heat pump was providing space heat as well as hot water.

The addition of the second use made obtaining permits in most jurisdictions more difficult than installing the systems simply as water heaters, as was done in TIP 292 (Eklund and Banks, 2015) and TIP 302 (Eklund, 2016). As in those earlier projects, the building official was required to exercise discretion under Section 104 of the International Residential Code, which allows use of alternate materials and systems.

Installation was scheduled at the Kalama site on February 1, 2017, but was canceled because the house was condemned by the Kalama Fire Marshall for asbestos, mold, and structural issues raised by evicted tenants. An alternate site was selected by Cowlitz PUD in Longview, WA, but the Longview building official categorically refused to permit any non-UL listed equipment in the jurisdiction.

The Spokane site homeowner and WSU began working to obtain permits from Spokane County and the Washington Department of Labor and Industries (L&I) to obtain permits in fall 2016. The electrical permitting in Spokane County is under L&I jurisdiction, which is under a statutory scheme (WAC 296-46B-999) that refers sellers of unlisted equipment to state-accredited labs and engineering firms for field determination that the equipment meets UL listing standards. From experience, WSU has learned that these services are very expensive, and research funds were not budgeted for them, and unlikely to approve non UL listed equipment. WSU applied for an exemption for pre-market field testing in the public interest, noting that subsection 999 (6) refers to “products offered for sale.” This request was denied making all of rural Washington unavailable for field testing emerging technologies.

Sanden International, the manufacturer of the HPWH, has obtained UL listing for the split system. This was a long and expensive process, and much of the knowledge and experience from these research projects was incorporated into the product that is UL listed and sold in North America. The use of the G3 at the Portland site will produce more useful information for the manufacturer because this was the first combined system test for the G3. The Eco Runo and Mitsubishi DHP+ systems researched in this project are not UL listed. The DHP+ will probably move from this field test directly to market, and UL listing will be procured for the prototype together with any improvements made as a result of the field study.

System Design and Installation

The three different systems each require unique system design, installation, and monitoring. The most developed were the CO₂ split system and the DHP+. The Eco Runo system is now installed in three different configurations. The system, of course, defines the type of monitoring that will ultimately take place. Baseline monitoring is also a custom project, depending on the existing systems. Each of the system types is briefly described in this section.

The CO₂ split system adds a space heating loop to the HPWH. The heating loop consists of two parts:

- The source side moves heated water from the tank to a heat exchanger, and
- The distribution loop delivers heat to the heat distribution system.

The design includes a backup heater between the tank and the heat exchanger. **Figure 1** shows a basic schematic of the CO₂ split system based on a central heat exchange. A second type of split system combined space and water heater was used in California, as discussed below.

Figure 1. Schematic of the CO₂ Split System

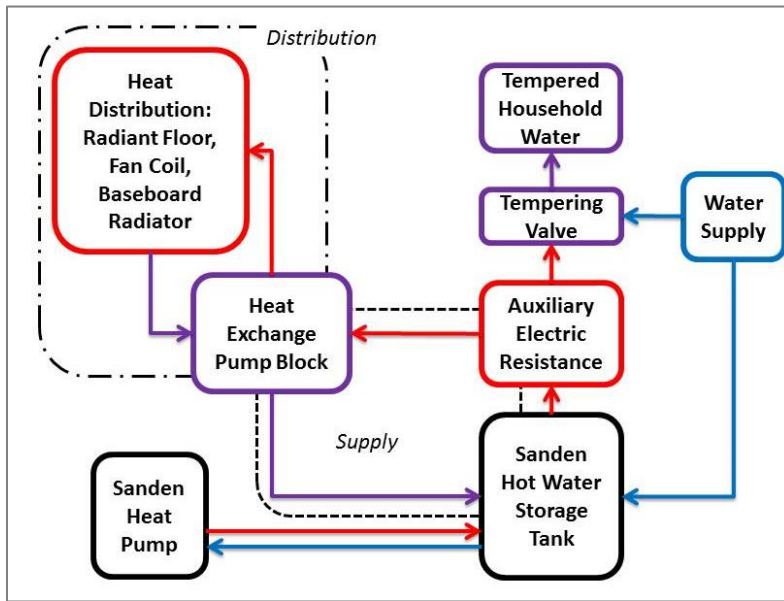

The DHP+ system by Mitsubishi is a large-capacity DHP that heats water, and provides cooling and heating to the space. **Figure 2** shows the basic outline of this system, with refrigerant lines moving from the heat pump in the outdoor unit to the indoor unit where air is heated or cooled and to the heat exchanger in the water heater.

Figure 2. Schematic of the DHP+ Water Heating System

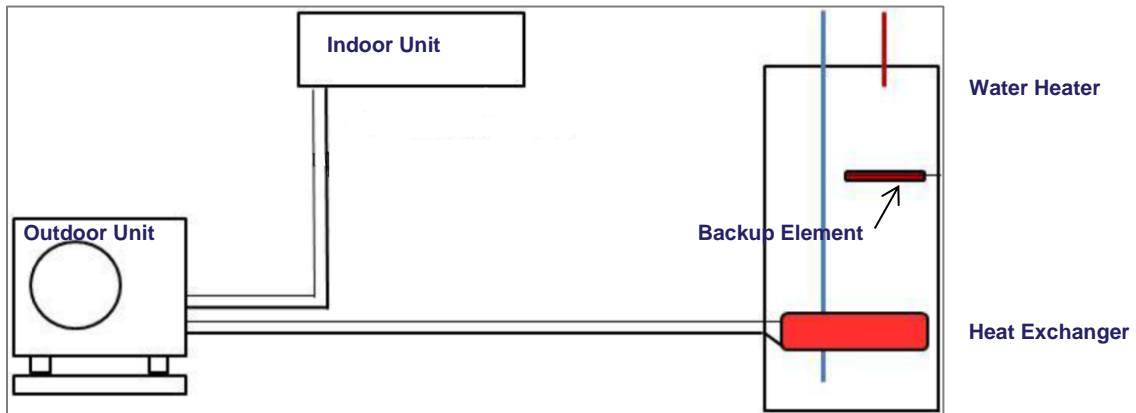

The Eco Runo system is designed specifically for space heating. The concept tested in this project is to turn it into a combined system by using a heat exchanger for hot water, as shown in Figure 3. The lab test revealed issues that had to be solved before the system could be placed in a field location.

Figure 3. Simplified Schematic of Eco Runo System

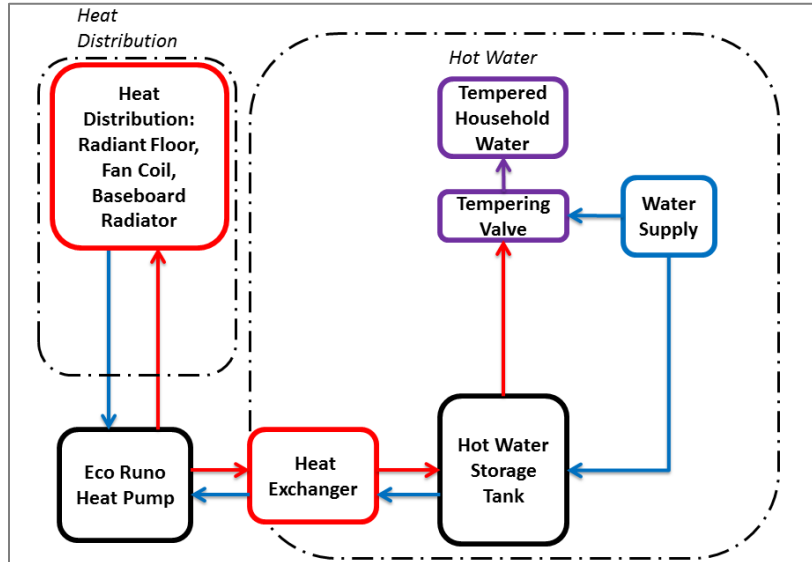

Challenges in Monitoring

The project was designed to use Onset U30 loggers and sensors which were installed at the first two sites. Onset then informed Ecotope, the monitoring equipment steward, that it no longer manufactured U30 loggers because ATT is phasing out the 1 and 2 gigabit infrastructure that supports them. In fall 2015, Onset informed Ecotope that it would charge \$450 instead of the budgeted \$290 for the data plan, and that the option was available for one year. Onset also offered its new system, the RX3000, for \$810 with a free one-year monitoring plan. At the time this report was prepared, two sites have U30 loggers and the project has purchased nine RX3000 loggers.

Issues with the new RX3000 loggers include poor reception in rural areas, one failed logger, and lack of an active local port that facilitates setup and data download when needed. Rural areas without either solid cellular or internet connection are particularly challenging.

The McCall sites are using SiteSage loggers. The equipment was designed primarily for use by homeowners to monitor energy use. Through its use in NEEA's Next Step Home program, this equipment now also provides a wide array of monitoring services.

The SiteSage monitoring equipment requires internet access in order to operate, so the home must be occupied and have internet installed and accessible before monitoring can be installed and commissioned. The equipment does not record data if it is not connected to the web, resulting in substantial loss of data.

At the time of this report, baseline monitoring is installed at four Sanden sites and four Mitsubishi sites (one Mitsubishi site dropped out due to delays in prototype installation). The biggest monitoring

challenges were flow meter accuracy and data gaps caused by the monitoring system. Calibration of flow meters on site using a micro-weir or an ultrasonic flow meter is recommended to test flow measurement and provide correction factors if needed. Loss of data by the monitoring system and by failure of internet connections was not expected, and this loss affected some sites more than others. Temperature sensors incorporated into the flow meters were also subject to failure.

Field Study Details

Site Summaries

The specific sites are typical of the regional heating zones they represent, as shown in **Table 1**. Most of the sites in Heating Zone 1 are warmer than the median value for that zone, but represent the most populated areas in the region. Spokane is warmer and McCall is much colder than the zone median.

Table 1. Heating Zones of Test Sites

Site Location	Heating Zone	Site HDD ⁶⁵ ¹	System Type
Grass Valley , CA	CEC CZ11	3,521	CO ₂ Split System
McCall, ID	RTF HZ3	8,976	Eco Runo, DHP+
Nevada City, CA	CEC CZ16	4,536	CO ₂ Split System
Olympia, WA	RTF HZ1	5,579	CO ₂ Split System
Portland, OR	RTF HZ1	4,241	CO ₂ Split System
Prosser, WA	RTF HZ1	5,251	DHP+
Rochester, WA	RTF HZ1	5,579	DHP+
Tacoma, WA	RTF HZ1	4,425	DHP+

Tables 2 and 3 provide specific information about each site.

Table 2. CO₂ Test Site Characteristics

Site Location	Grass Valley	McCall 1	McCall 2	Nevada City	Olympia	Portland
HD ⁶⁵ D	3,521	8,976	8,976	4,536	5,579	4,109
Design T°F	19	-16	-16	14	22	23
Heating System	CO ₂ Split	Eco Runo	Eco Runo	CO ₂ Split	CO ₂ Split	CO ₂ Split
Dist. system*	FAF	RF	RF	FAF	RP	RP
DHW T°F	143	125	125	121	120	129
# Occ.	2	4		2	2	4

*RF=radiant floor, RP=radiant panel, and FAF=forced air furnace

**The homes in Grass Valley, Nevada City, and Olympia do not have data on any heating system except the Sanden CO₂ split system. Nevada City and Olympia have no backup heat. Portland has an electric resistance (ER) heater in line with its HRV.

Table 3. DHP+ Test Site Characteristics

Site Location	Prosser	McCall 3	Rochester	Tacoma 1	Tacoma 2
HDD ⁶⁵	5,251	8,976	5,579	4,425	4,425
Design T°F	14	-16	22	24	24
Heating System*	ER + Wood	ER Zonal + Propane	ER Zonal	ER Zonal	ER Zonal
DHW T°F	134	138	120	?	?
# Occupants	5	2	2	?	?

*Distribution in these homes is primarily radiant and convective transfer from ER heaters.

Monitoring Setup

The measurements recorded by the monitoring system are listed below. All data was taken at 1-minute intervals. Please note the code names that match the identification of each channel on the schematics:

¹ Source: Western Regional Climate Center. All heating degree days (HDD) are calculated with 65°F base.

Water flow, time, and volume (FM = flow meter).

- Through space heating source loop measured on return to tank or heat pump (FM-1).
- Through hot water tank measured at the cold water inlet (FM-2).
- Through heat exchanger to hydraulic separator (FM-3). This is used only on the Eco Runo installations.

Temperatures

- Cold water supply (CWT)
- Hot water (HWT)
- Tempered water to house (MWT)
- Outside air temperature (OAT)
- Inside air temperature in conditioned space (IAT)
- Supply water from hydraulic separator to heat exchanger (XSWT)
- Return water from heat exchanger to hot water tank or hydraulic separator (XRWT)
- Temperature of water supplied to the heat pump (HPST)
- Temperature of water returned from the heat pump (HPRT)
- Temperature of water exiting auxiliary electric demand heater (McCall sites only)

Power measurements

- Time and amperage of outdoor compressor unit (compressor, fan, and pump) (HP)
- Time and amperage of backup heating loop electricity use (HA)
- Time and amperage of heat exchange supply and distribution pumps and controllers (HX)

The main monitoring collection device was an Onset U30 or RX000 with cellular or internet connection allowing daily data download and remote operation. This quality assurance ensures that issues are identified and corrected as soon as possible. The following monitoring equipment was used:

- U30 GSM or RX3000 (includes 10-port option and data plan)
- WattNode (WNB-3Y-208-P option 3)
- 50 amp split core alternating current (AC) transformers
- 12-bit temperature sensors with 6- or 17-meter cable
- Water flow meter sensor (T-Minol-130)
- Water flow meter (pumps and controls PCM-075-10PG for low flow)
- 10K ohm type 2 thermistors with temperature documentation
- Temperature wells for water temperature sensors

Figure 4 shows the Onset monitoring configuration for a typical split system. Onset is limited to 14 channels that are carefully selected to provide key information. The two California sites are configured differently from the schematic; they do not have X-Block heat exchangers and send potable water to the heat delivery system.

Figure 4. Onset Monitoring Configuration for a Typical Split System

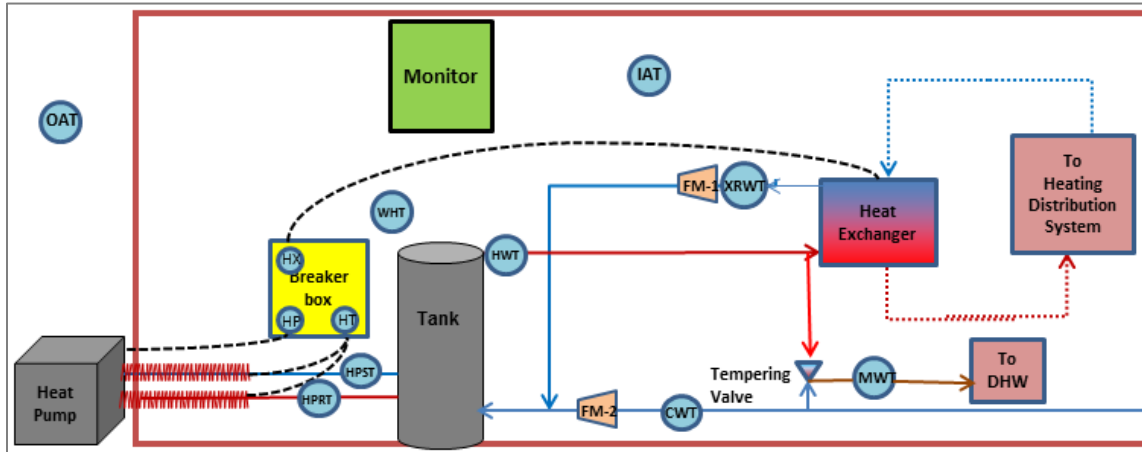

The two Eco Runo sites in McCall, ID, are sites inherited from TIP 326, where the original split systems experienced power out freezing, defrost, and capacity issues. They have SiteSage monitoring systems.

SiteSage Energy Monitor must have an internet connection so data can be downloaded and settings on the logger can be controlled remotely; the system only records information when connected to the internet and gateways frequently must be rebooted onsite. A schematic of this monitoring system is provided in **Figure 5**. The following monitoring equipment was used:

- Emonitor + Gateway
- INDAC sensor controller
- (2) Temperature + % relative humidity (RH) 1-wire sensors (indoor and outdoor)
- (3) Temperature wells with 1-wire temperature sensors
- (2) Grundfos flow sensors + temp model VFS 2-40
- (1) Grundfos flow sensor +temp model VFS 1-20

Figure 5. Field Monitoring Setup for Eco Runo Sites in McCall, Idaho

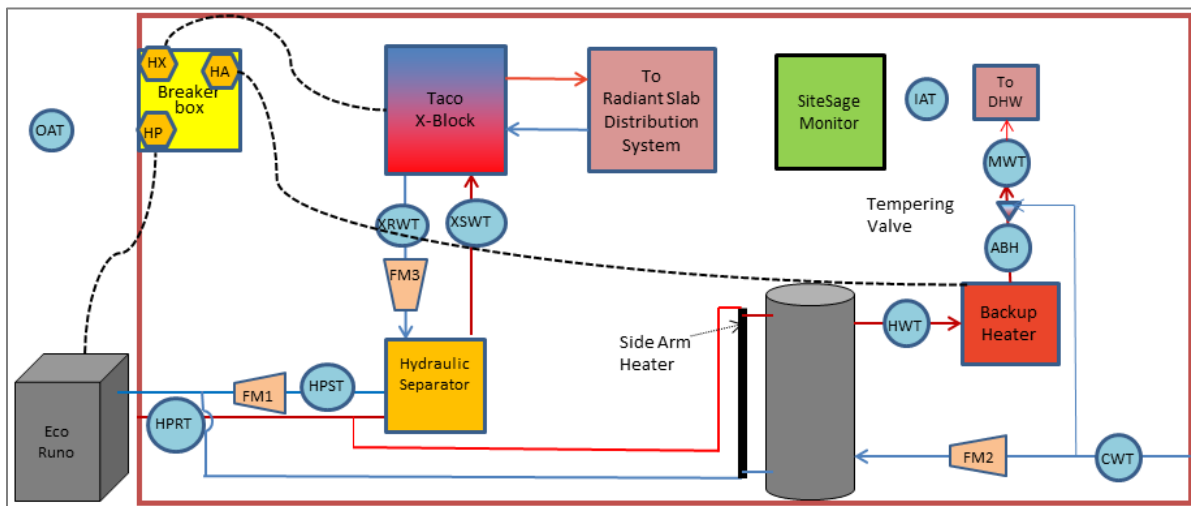

Field Study Data Analyses

The period covered by this analysis is from the time baseline monitoring began, which varied by site, through July 31, 2017, except for the McCall sites, which focus on the heating season.

The analysis of the split systems examined the performance of the system for space and water heating for the Olympia and California sites. Operating parameters of the DHW system include: the temperature of the system cold water supply, heated water, and tempered water; and the calculated volume of water used to temper the hot water before use. The total volume of water used and daily use averages were also calculated for DHW. In addition, the characteristics of the space heating loop were examined for temperatures, operating parameters, and energy used under representative conditions.

Domestic Hot Water

Calculating DHW use requires the following elements:

- Average temperatures by flow event or by day for cold water supply, hot water, and tempered water for the DHW supply.
- Thermal energy required to heat cold supply water for each flow event.
- Volume of water added to temper hot water for each flow event.
- Volume of total water for each flow event.

To calculate accurate temperatures for cold supply water, hot water, and tempered water for DHW, at least 3 minutes of consecutive flow was required. Temperatures were then calculated by dropping the initial reading and averaging over the remaining readings for a given flow event (or draw). Daily averages were used as the representative temperatures for short-duration draws that were less than 3 consecutive minutes. When only short draws occurred during a given day, the daily average water temperatures from adjacent days were used.

Only water volume flowing into and out of the HPWH tank was metered via data loggers, so additional water added to temper the hot water was calculated for each flow event by using the known water flow (gallons) and the difference between the average daily tempered water flow and the average daily cold or hot water temperatures, respectively. Total tempered water flow for each flow event was the sum of the cold water flow and the added water.

Average water temperatures were used to calculate the thermal energy needed to heat the cold water for each draw. The energy is calculated via the familiar calorimetric equation shown below, where p is the density and C_p is the heat capacity of water.

$$\text{Equation 1: Energy} = \text{Volume} \times p \times C_p \times (\text{Temperature 1} - \text{Temperature 2})$$

In the specific case of DHW use, the energy in Btu is defined as Q_{dhw} , Temperature 1 is the tank outlet (HWT), and Temperature 2 is the tank inlet (CWT) temperature. Volume is the flow through FM2.

Space Heat

The relevant energy values for the space heating systems were calculated using the flow event calculation principles used for DHW and Equation 1 but with values substituted as required by the different heating system designs.

Overall System Efficiencies

Water heating is rated with Energy Factors; space heating is rated by Coefficient of Performance (COP) or Heating Season Performance Factor (HSPF). The combined system performance has been designated as a Field Energy Factor (FEF). This accounts for all system inefficiencies such as tank loss, pipe loss, pump energy, controls, defrost, and freeze protection. FEF efficiencies are calculated as:

$$\text{Equation 2: FEF} = (Q_{\text{dhw}} + Q_{\text{system}}) / Q_{\text{input}}$$

where Q_{input} is the sum of energy inputs to the HPWH (HP), auxiliary heat (HA), heat exchanger block (HX), and heat tape (HT).

Space and Water Heating Efficiencies

For combined systems, heat is provided by one heat source for both space and water heating simultaneously, so it is impossible to calculate a definitive efficiency for each end use. This is particularly true for a heat pump because its efficiency varies with OAT, supply water temperature, and load. Thus, a period of water heating only during the summer cannot be used to determine its portion of the load in winter. The lab test was designed to quantify the individual efficiencies for space and water heating as well as combined function efficiencies.

Field Study Results

Three different system types are covered in this report. All are combined space and water heating systems. One type is split systems using the Taco X-Block configuration designed in TIP 326; a second type is a split system, used in California, that delivers potable water to the heat distribution system; and a third type uses Eco Runo 3-ton heat pumps with propylene glycol in the heat pump loop and heat exchange DHW systems. The results for the split systems and Eco Runo are discussed separately.

One of the TIP 326 type split systems has only water heating results because the homeowner decided to change the heat delivery system, took three months to design it, and delayed installation until August 2017. WSU's plan to obtain a full heating season of combined system performance data by rushing to install the system on November 4, 2016, was completely foiled. The upside is that it provided eight months of water heating-only data on the new Gen3 split system that is directly comparable to the original TIP 292 field results. It provides keen insight into the impact of operation parameters on system performance.

Split System Combined Space and Water Heating

The California systems studied are retrofits in existing homes that have been thermally upgraded. The comparison case flow data from a retrofit home in Olympia, WA, was too corrupt to allow analysis, so data from a new home with no backup system in Milwaukie, OR, was used for comparison. This site has a high temperature radiator distribution system like the Olympia site for which it substitutes.

Two different system configurations based on the Sanden split system HPWH were monitored. The first is the system based on an X-Block that exchanges heat from the source to a distribution loop as shown in **Figure 6**. This is the system that is installed at the site in Oregon.

Figure 6. System Based on an X-Block

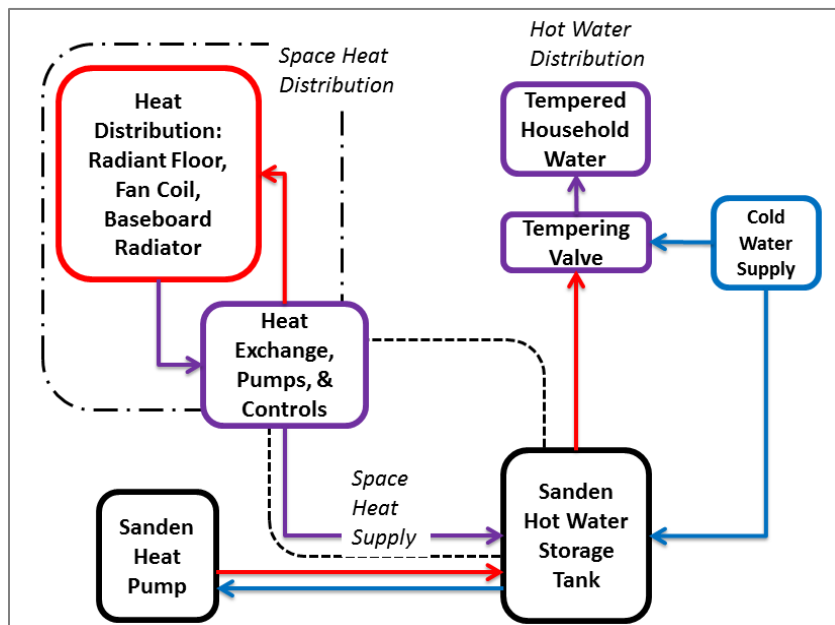

The California systems are both FAF conversions done by Balance Point Inc. (Balance), a California home retrofit company. The research on these homes was funded by PG&E.

Figure 7 shows the basic layout of the home located in Nevada City. The home located in Grass Valley is plumbed slightly differently, taking its heating water prior to the mixing valve. It also has an air source heat pump as an auxiliary heat system, which supplants the Sanden heat pump when it operates.

Figure 7. Basic FAF Conversion Layout

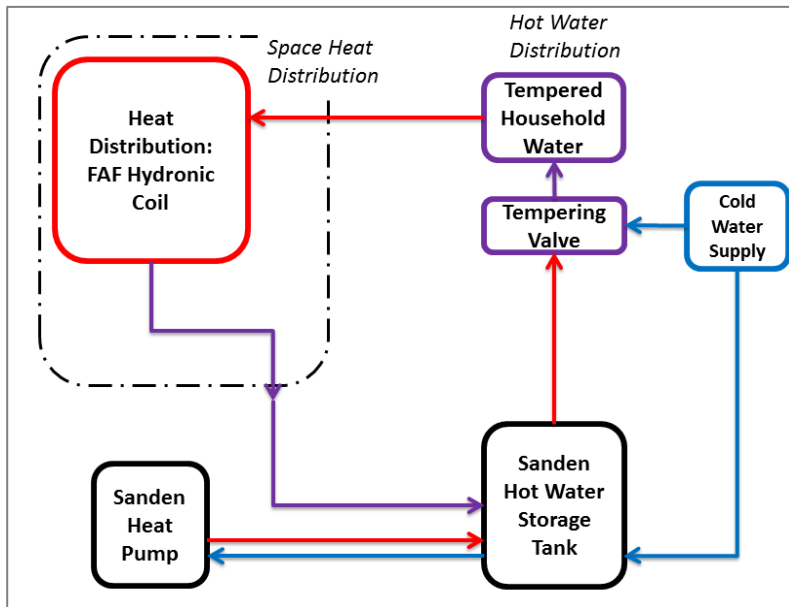

The FEF for the Grass Valley and Nevada City sites plotted by OAT are shown in **Figure 8**. Note the similarity of the system efficiencies at the heating season temperatures from below 40°F to 60°F, even though Grass Valley has an auxiliary heating system. Note also that when these sites move past the heating season, Grass Valley pulls ahead in efficiency. Evidently something that impacts efficiency during both heating and non-heating seasons is at work here.

Figure 9 shows the different water temperatures at the California houses. At Grass Valley, the high-temperature water labeled “Outlet Temperature” was sent to the heating system. Nevada City takes its heating system supply post mixing valve, which is the “Tempered Water Temperature.”

This is a difference of approximately 30°F in heating system supply temperature between the two systems. The question is whether this results in a difference in space heating ability or comfort. **Figure 10** shows the average daily inside and OATs during the monitoring period.

Both sites are kept at approximately the same interior temperature, and the temperatures outside are similar during the heating season. The Nevada City low-temperature strategy appears to work.

Figure 8. Weekly Field Energy Factor by OAT at the California Sites

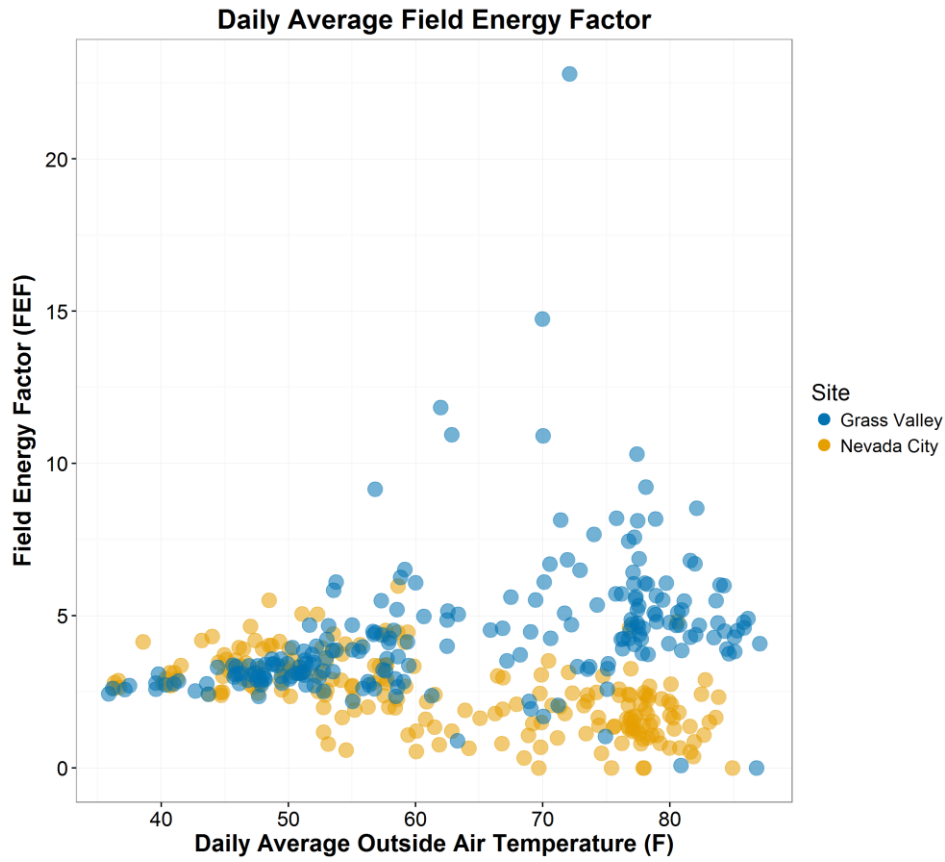

Figure 9. Average Daily Source, Heated, and Tempered Water Temperatures

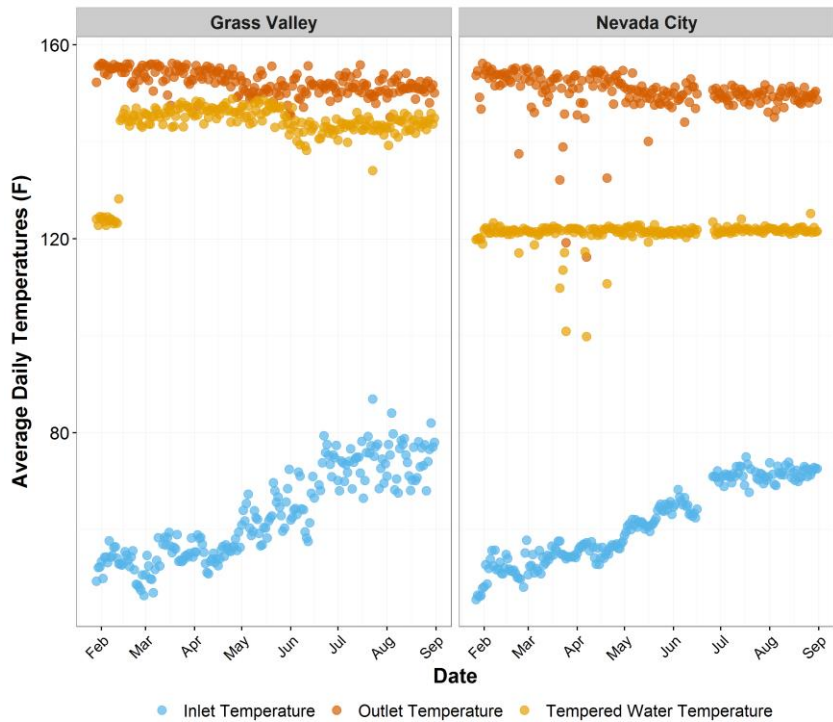

Figure 10. Average Daily OAT and IAT

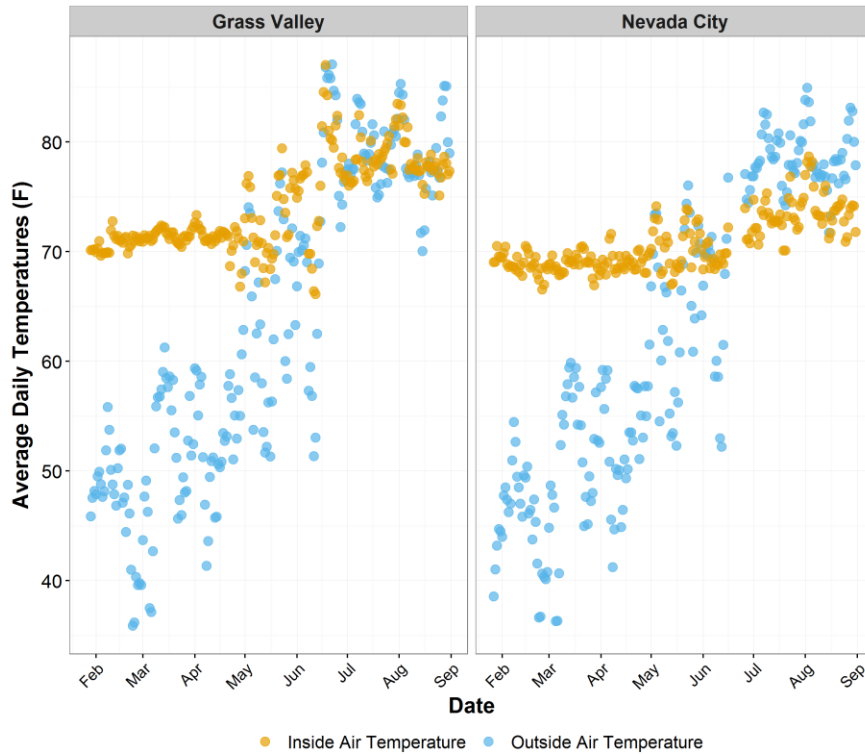
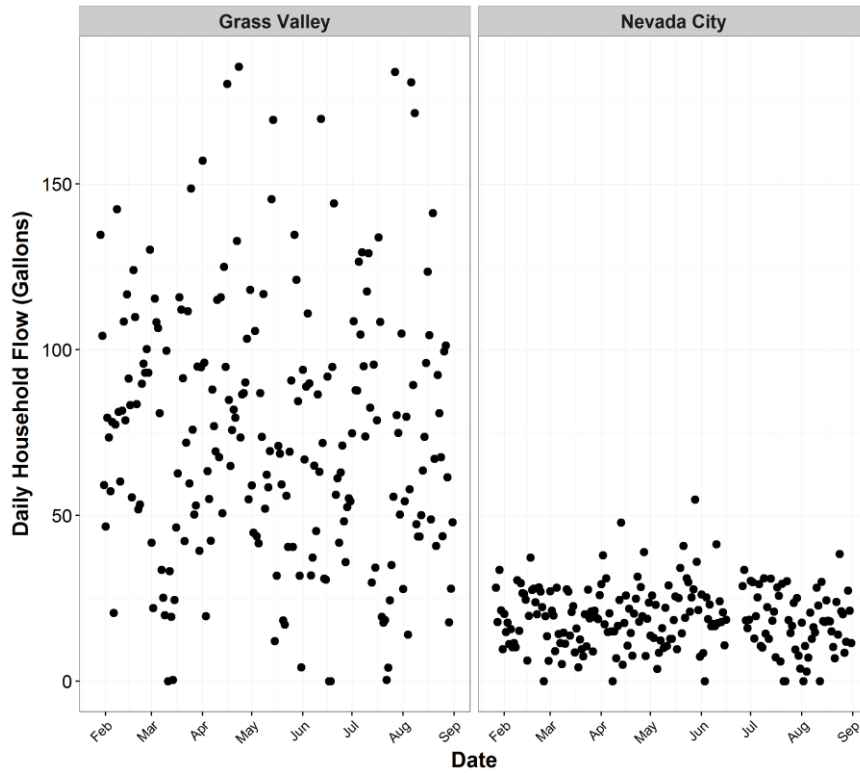

Figure 11 shows the hot water use at both sites. There is a significant difference. While Figure 9 shows slightly colder supply water in Nevada City, the only significant difference that cuts across heating and non-heating seasons is volume of hot water use.

Hot water use brings cold water into the system, which enhances performance. The impact on water heating is discussed in detail in the next section. The impact on heating is discussed here in the context of comparison with the Oregon site. The impact of high hot water use during the heating season compensates for all the auxiliary heat used in Grass Valley when FEF is calculated. It even compensates for the significantly higher operating temperature at Grass Valley.

Figure 11. Daily Average Hot Water Use at the California Sites



The site in Milwaukie, Oregon, has an X-Block heat exchange, pump and control module and, like Nevada City, no auxiliary space heat. The site distributes heat through radiators, which is also a high-temperature system. **Figure 12** shows the OATs at the three sites. It appears that temperatures were comparable at all sites during the monitoring period. Details are provided in **Table 4** and **Table 5**.

Figure 12. OAT with Daily Average and Maximum and Minimum

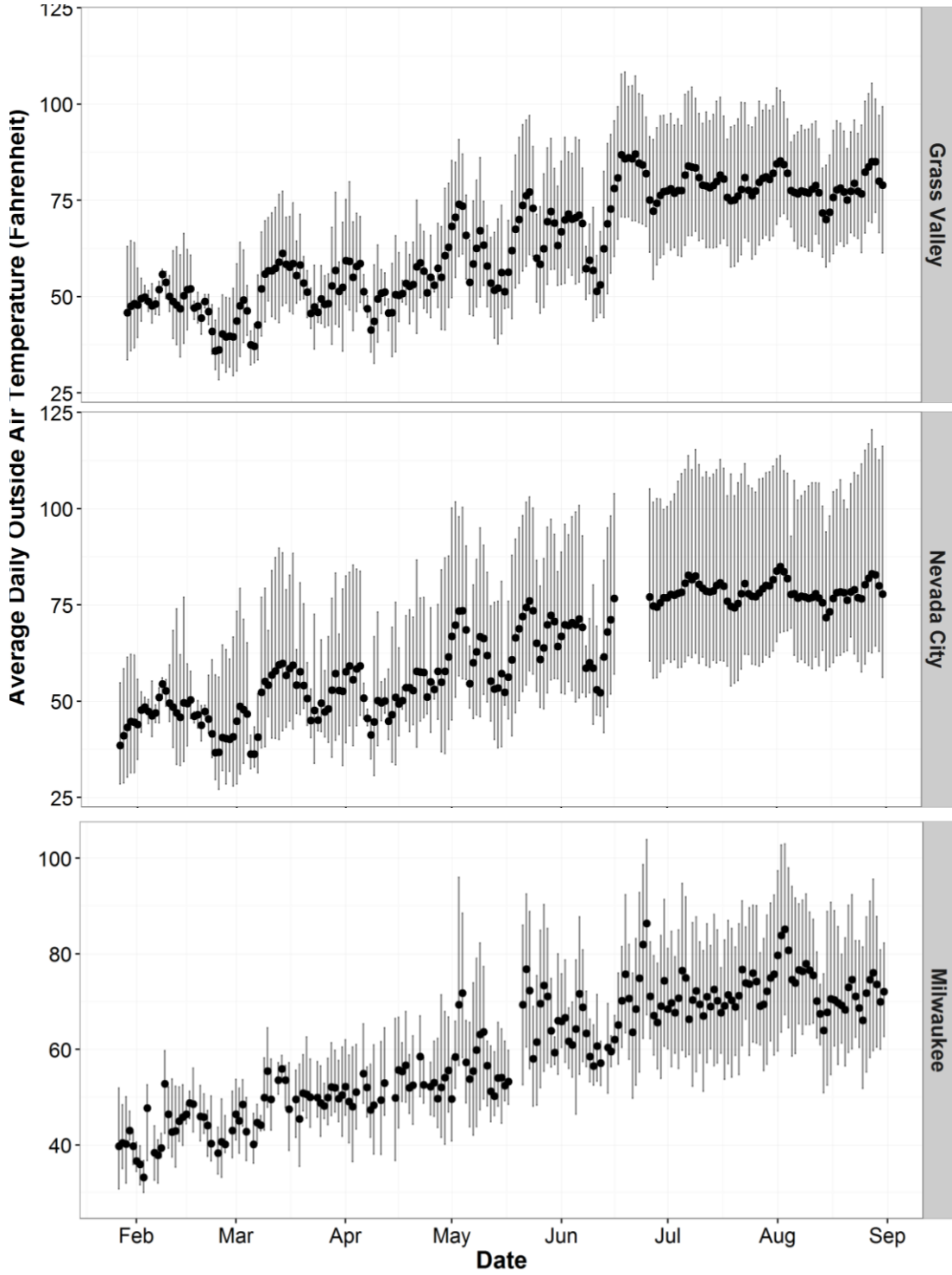

Table 4. Data from Monitoring Showing Temperatures, Water Used, and Days Monitored*

Site	OAT (°F)		XRWT (°F)		DHW (GPD)		FEF		Days Sampled	
	H	NH	H	NH	H	NH	H	NH	H	NH
Milwaukie	44.3	64.2	105.1	59.4	51	**2.2	3	42	155	
Grass Valley	47.9	67.8	77.2	75.2	75.8	3	4.9	45	167	
Nevada City	47	66.9	77.9	19.8	19.5	3.2	2.3	47	154	

* Includes data from 1/27/2017 through 8/31/2017

** The heat season FEF was calculated using monitored temperature data and UA_o for the Milwaukie site because meters were not accurately measuring flow on either side of the heat exchange. The building heat loss for the monitored period was added to the hot water load and divided by the kWh for heat pump and pump and controls to produce the FEF.

Table 4 shows that the average OAT at these sites during heating and non-heating seasons was very similar, with the Oregon site being colder as expected. The return temperature from the heating system (XRWT) at both California sites was also close, especially given the 30°F disparity in supply temperatures, and the return temperature was cool enough to optimize heat pump performance. Return at the Milwaukie, OR, site was in the high range which reduces heat transfer efficiency. At both Milwaukie and Grass Valley, the cooling effect of 53°F supply water coming in to be heated as DHW had a significant impact on boosting heat pump exchange effectiveness thus increasing system efficiency.

The average FEF during the heating season was good at all three sites. However, when the system no longer has warm (or hot) water entering the tank from the heating system during the non-heating season to mix with 66°F supply water, the FEF should improve. It did at Grass Valley and Milwaukie but declined at Nevada City. This may be due to much lower DHW use which results in comparatively higher standby losses.

Table 5. Conditioned Floor Area, Heat Loss Rate, and System Power Use

Site	CFA (sq. ft.)	UA+ Infiltration	HP (kWh)		Aux (kWh)		Pump & Control (kWh)		Total kWh	
			H	NH	H	NH	H	NH	H	NH
Milwaukie	1,738	231	918.8	625.1	0	0	64.8	14.5	983.6	639.6
Grass Valley	1,680	407	692.8	854	312.2	0	155.1	163.3	1,160.1	1,017.3
Nevada City	1,690	210	502.4	480.2	0	0	54.6	43.1	557	523.3

Nevada City uses about half the energy as Grass Valley. Given that the site’s heat loss rate (UA + Infiltration) and hot water use are much lower than Grass Valley’s, this makes sense. Grass Valley needs more energy for space and water heating, but is doing that much more efficiently.

The three different types of systems compare well in both performance and overall energy use. A conservative estimate of annual energy use per square foot of conditioned floor area per year is 1.5 kWh at Nevada City, 2.6 at Milwaukie, and 3.2 at Grass Valley (**Table 6**). These are low numbers for space heat alone, but they also include all the hot water. Table 6 compares these values to the same value derived from adding the Residential Building Stock Assessment field metering result for air to air heat pumps to the same measured hot water use for the house as if it were provided by a standard HPWH. Using field measured performance data. Ecotope, *Residential Building Stock Metering Study*, and B. Larson, *Heat Pump Water Heater Model Validation Study*.

Table 6. Comparison of Annual kWh for Space and Water Heat per Square Foot of CFA*

	CO ₂ Split System Combi	Air-to-Air Heat Pump and Tier 2 HPWH in Garage
Milwaukie	2.63	4.49
Grass Valley	3.18	4.59
Nevada City	1.52	3.6

* CO₂ split system vs. RBSA air-to-air heat pump and field-measured HPWH data

The RBSA, though based on sites in the Pacific Northwest, is relevant to the California sites. Nevada City is historically colder than Milwaukie, Oregon, making this a meaningful comparison. For Grass Valley, which is warmer than Nevada City and Milwaukie, Oregon, a lower metered energy value from the RBSA was used instead of the weather-normalized value. The metered value represents a warmer year.

The dramatic comparison of the combined system energy use values with sites representative of the in-place reality demonstrate a great opportunity. This is a technology worth serious consideration.

Water Heating Insights: Impact of Hot Water Volume on Performance

The daily flow and energy use is within the range of the TIP 292 field study results, which showed an average slope of flow to energy of 0.04 kWh per gallon (Figure 13). This, however, is not an efficiency measure but a relationship between heat pump energy and volume of hot water use. The FEF is the ratio of the total energy delivered by the system to the total energy input. The FEF of the G3 site was 1.5, while the average FEF of the original TIP 292 field sample was 2.36 (Figure 14).

Figure 13. Daily Flow and Energy Use

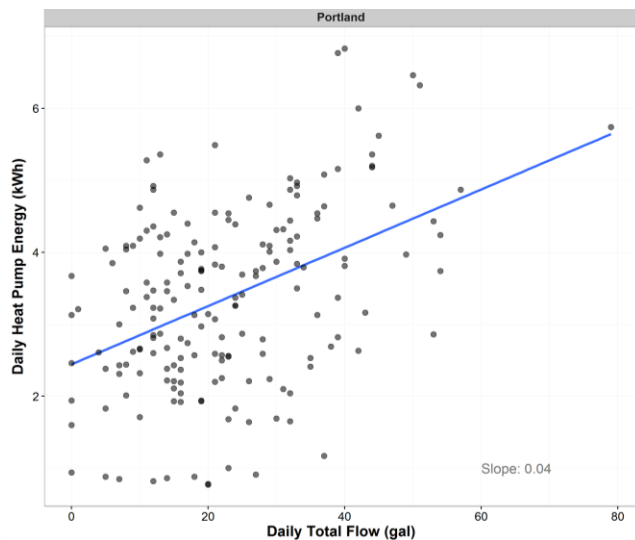

Figure 14. Daily Average Field Energy Factor

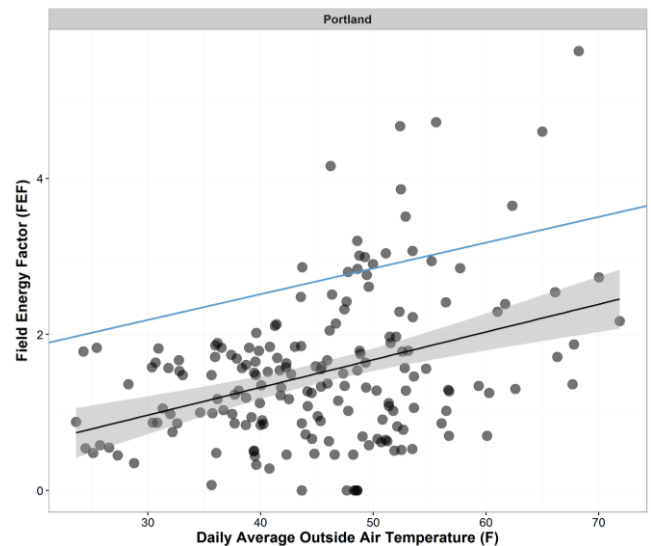

Figure 13 relates daily flow on the X-axis to the value of both the daily quantity of heat in the hot water delivered (Q_{dhw}) and the heat pump energy invested in heating the water on the Y-axis. Note that daily heat pump energy does not appear to increase proportionally to daily hot water energy produced. As the amount of water heated increases, the efficiency of the system rises as well at least in part because of proportionally smaller standby losses.

Table 7 lists the comparable values for the four systems in the original TIP 292 field study and for the G3 field installation. Note the relatively low hot water use, the low average FEF, and the high kWh per gallon.

Table 7. Comparable Field Test Values

Site	Sampled Days	KWh/Day	Gal/Day	Av. FEF	KWh/Gal
Addy, WA	266	6.8	98.7	2.42	0.07
Corvallis, MT	340	6	75.6	1.88	0.08
Portland, OR	280	3.5	45.4	2.30	0.07
Tacoma, WA	367	5	80.5	2.83	0.06
G3	182	3.4	23.8	1.50	0.15

Low flow appears to be a major factor in the efficiency of the system. If the volume of use was the Pacific Northwest average of 15 gallons per person per day, it would be 45 gallons – comparable to the original Portland, OR, site. But this volume is half that flow, on average. Another factor may be that most of the time period monitored was during the heating season in the cold winter of 2016/2017, while TIP 292 results spanned warmer non-heating seasons (as well as heating season months).

Ways to increase efficiency include shifting recovery operation to non-peak hours which lowers the average tank temperature and to supply cold water to increase heat exchange in the outdoor unit when it does operate as shown in the Demand Response Lab Test Report (Larson, 2015). **Figure 15** shows the improvement in efficiency from this operation shift.

Figure 14. System Annual COP in Oversupply vs Number of Occupants – Portland Climate

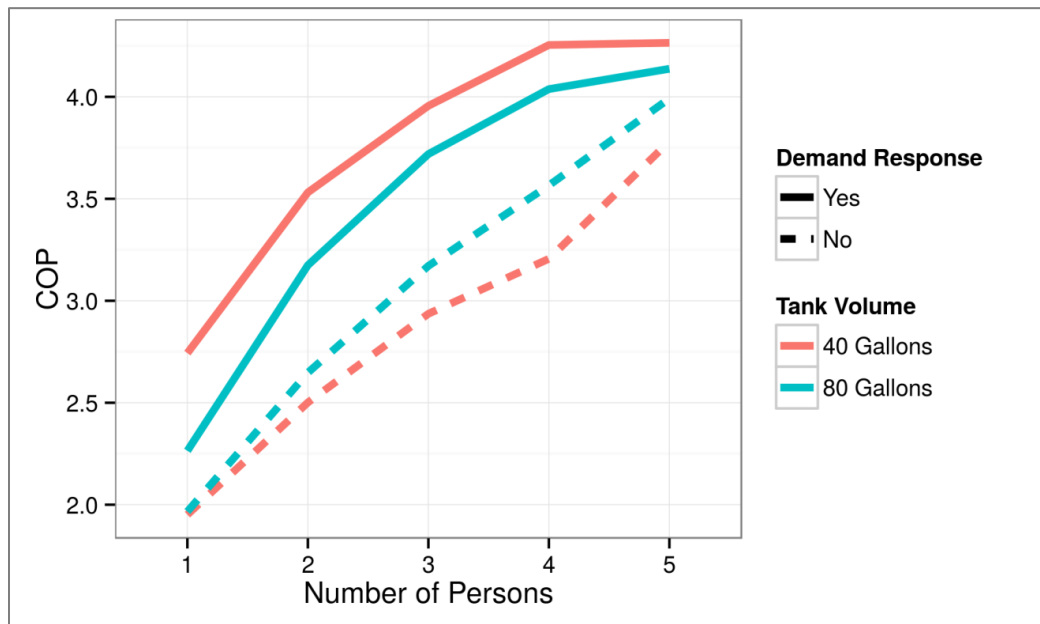

Other strategies include increasing hot water use through bathing and hot tub use. This is the main reason for development and sale of the CO₂ refrigerant heat pump water heater in Japan. Combining the strategies would significantly increase efficiency but would also increase the risk of running out of hot water with the smaller tank.

Eco Runo Cold Weather Space Heating Performance

The Eco Runo is an 11 kW (37,500 Btu per hour or 3.13 ton) output hydronic heat pump with CO₂ refrigerant manufactured by Sanden for space heating. In cooperation with Sanden and NEEA, the two McCall sites where the split system CO₂ heat pumps studied in TIP 326 failed (due to capacity and defrost issues during the winter of 2015/16), were retrofitted with Eco Runo heat pumps and sidearm water heaters to replace the combined space and water heating systems. The Eco Runo systems were installed in the McCall homes on February 21–24, 2017.

Winter in McCall is severe and prolonged, and provided some cold weather for the Eco Runo heating test reported here. Temperatures as low as 10°F were reported during the period in which the Eco Runo took over all space heat function from the 28 kW ER backup heater. The heat pumps were installed with propylene glycol in the heat pump loop that flowed to the supply side of the Taco X-Block and through the side arm water heater. The backup heaters were moved to the hot water lines, where their job became preventing cool showers.

These results show the heating season performance only. Although sidearm water heaters were installed at the same time as the heat pump, the aquastats were not identified, ordered, and installed until the non-heating season, which is not part of this report. However, the sidearm heaters did serve as preheaters for the DHW; that performance is analyzed and included in the FEF.

Figure 16 shows the OAT measured at the McCall Eco Runo sites during the period from installation through May 2017. The daily average is shown by the dot, with lines showing daily highs and lows.

Between February 24, 2017, and the end of May 2017, the heat pumps were subjected to a cold weather test. During the days when the heating system ran, the average daily temperature was 37.5°F and low temperatures reached 10°F on the coldest day. This accurately represents cold weather in the region's coastal zones and milder inland climates.

Figure 17 shows the average daily indoor and exterior temperatures for the period studied. Both sites were kept at habitable temperatures. McCall-1 was primarily occupied on weekends and McCall-2 was occupied full time.

As shown in Figure 5, the systems were set up to heat a concrete radiant slab and to heat water through a sidearm heater retrofitted to the 83-gallon tank that served the original split system. The 28 kW ER heater that provided all space and water heat between the removal of the split system and installation of the Eco Runo was retained as a demand heater for the DHW. During the cold weather test, the sidearm heaters became preheaters for the DHW demand heater and operated only when the thermostat called for space heat.

Figure 18 shows the DHW temperatures at the two McCall sites during the cold weather heating test. Note the preheat values, which are the temperature of the water supplied to the demand heater. The preheat contribution at McCall-1 was greater, probably due to time between hot water uses. The mixed water temperature sensor was not being recorded at McCall-2 during this test period.

Figure 15. OAT Measured at McCall Eco Runo Sites: Installation through May 2017

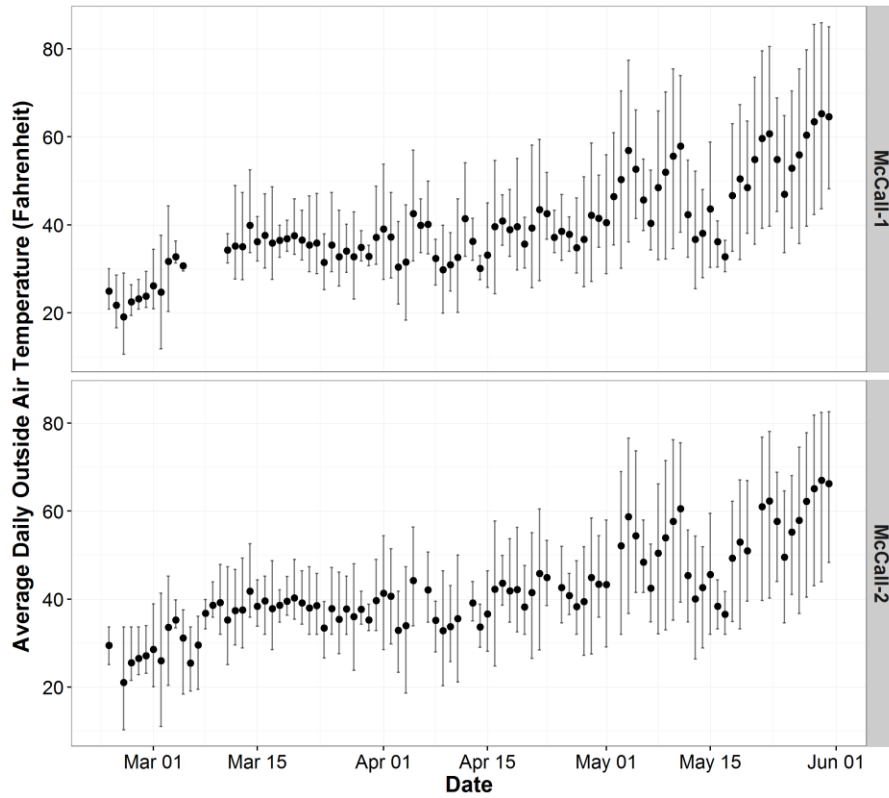

Figure 16. Average Daily Indoor and Exterior Temperatures for Study Period

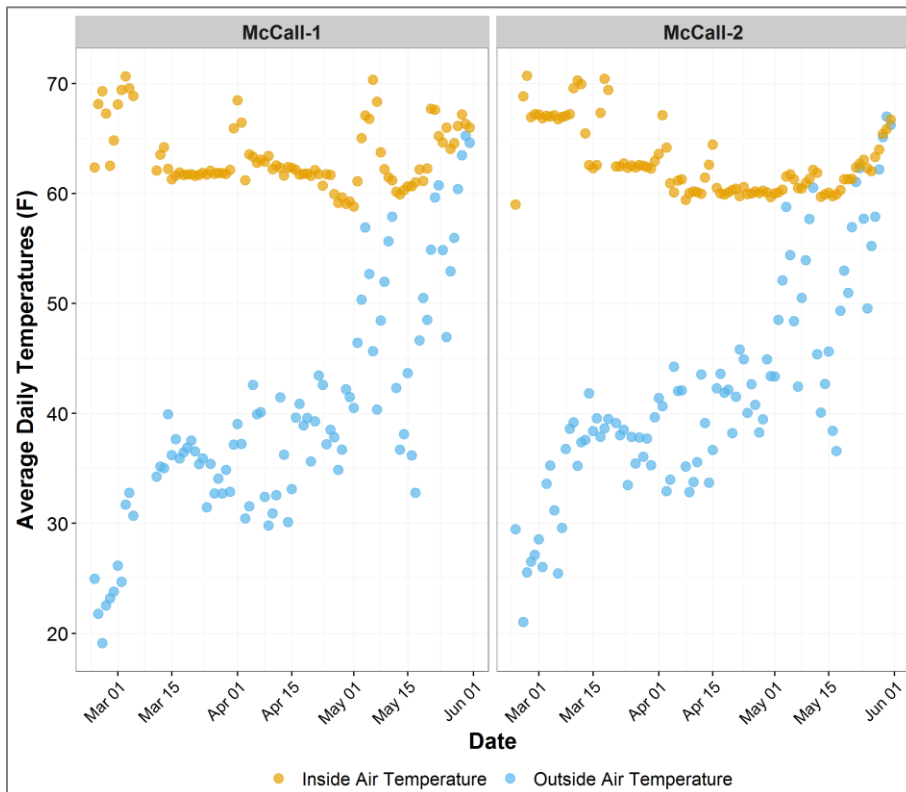
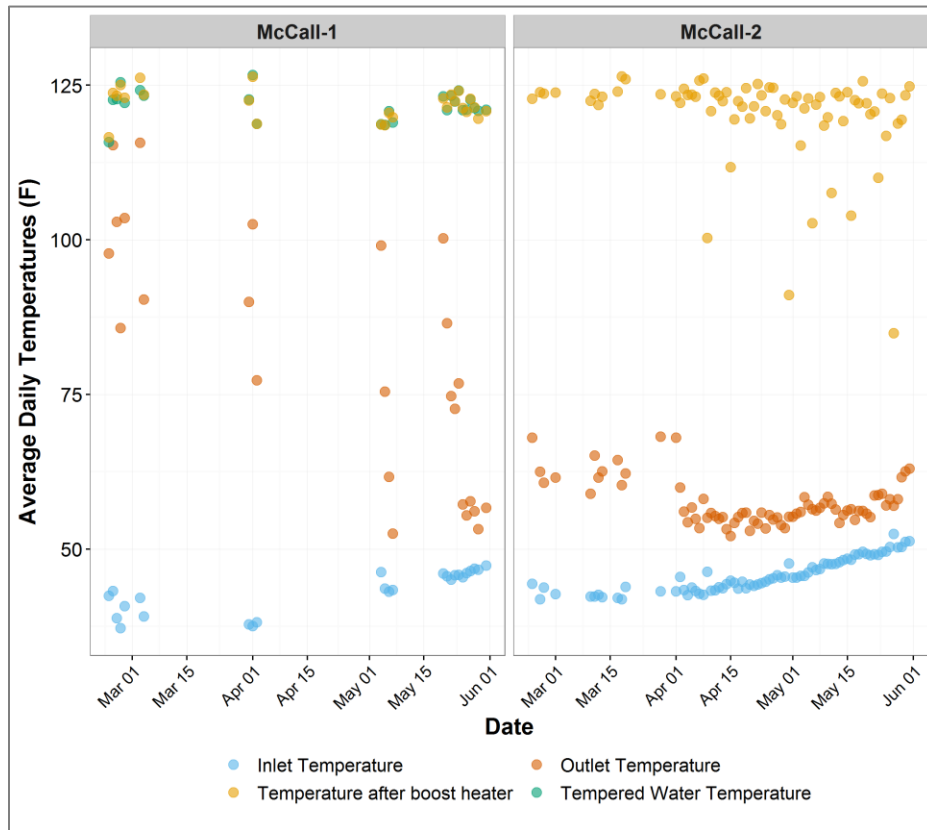

Figure 17. DHW Temperatures at McCall Sites during Cold Weather Heating Test



This graph also provides insight into occupancy. The intermittent DHW use at McCall-1 indicates weekend use, while the daily use at McCall-2 shows fairly consistent occupancy during most of the test period. Since both sites were heated during the test, and the DHW heat analyzed is incidental to space heat, frequency of hot water use is not particularly relevant, though it does impact the amount of preheat that can be measured and credited to FEF.

The total FEF shown in **Figure 19** includes the heat provided to the space heat loop plus the energy invested in preheating the DHW by the passive flow through the sidearm heater during space heating. The graph shows that either the Eco Runo performed differently at the two sites, or the flow and temperature measurements are different. Unfortunately, no extended data collection is planned and no field budget is available to calibrate the flow meters and temperature sensors at these sites, which were added to the project in its last quarter.

Water heating is not covered in this report, but sufficient experience was gained in the period following the heating season test to state that the Eco Runo does not heat DHW effectively or efficiently through a side arm heater acting as the primary water heater, though it does provide preheat incidental to a heating call. At this point in system development, the only effective option for full DHW from the Eco Runo is an indirect heater.

Figure 18. Daily Average Field Energy Factor – Space Heating plus DHW Preheating

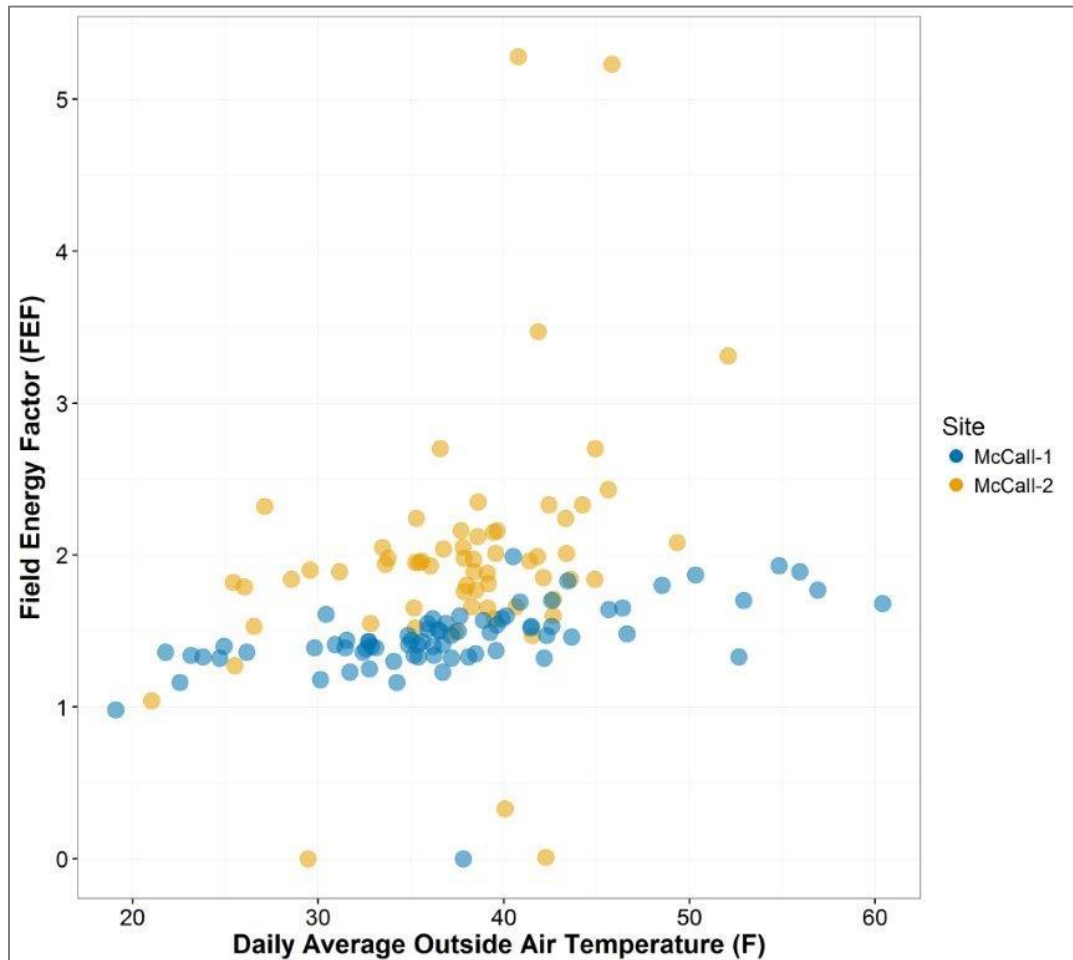

The performance at McCall-2 is comparable to the field-tested performance of air-to-air heat pumps in warmer climates, as reported by Ecotope in the State Technology Advancement Collaborative Report (June 30, 2008). The field COP in that study ranged from 1.4 to 2.9. It is important to note that the Eco Runos were also providing DHW preheating, which adds a different dynamic to the system demands, impacts system performance, and adds another end use.

The values in Figure 19 for both McCall sites are not out of line with the results of the Eco Runo lab test conducted by Ecotope shown in **Table 8** and included as Appendix A. The FEF shown in Figure 19 is similar to the COP; both include total system input.

Table 8. Lab Space Heat Test Values

Test Type	Test Conditions	Space Heat Added (kWh)	Domestic Water Heat Added (kWh)	Input - Total System (kWh)	Equipment COP
Space Heat Only	5°F air	29.6	0	17.8	1.66
	17°F air	33.2	0	18.3	1.82
	35°F air	29.7	0	14.9	2.00
	47°F air	34.8	0	16.6	2.10

Study of Combined Systems Retrofitted into Manufactured Homes

PNNL conducted performance and DR testing on sites representing a potentially large retrofit sector: electrically heated manufactured homes. The tests were conducted at the PNNL Lab Homes Test Center.

The PNNL Lab Homes are two factory-built homes installed side-by-side on PNNL's campus in Richland, WA. They provide a platform for evaluating energy-saving and grid-responsive technologies in a controlled environment. These 1,500 ft² homes have three bedrooms and two bathrooms, and are equipped with a 7.7 HSPF (Heating Seasonal Performance Factor) heat pump and an electric FAF. The insulation levels include R-22 floors, R-11 walls, and R-22 ceiling insulation. The windows are aluminum frame, double-glazed units with .69 U factors.

Lab Home A serves as the control home, and the experiments are run in Lab Home B. In these tests, both homes were equipped with CO₂ refrigerant, split system heat pumps that provided space heat through a hydronic coil mounted on the electric FAF with heat pump. The heat pumps also provided DHW. The system schematic is shown in **Figure 20**. The backup heater, heat pump, and resistance elements of the furnace were not used during the tests.

Figure 19. Lab Home A System Schematic

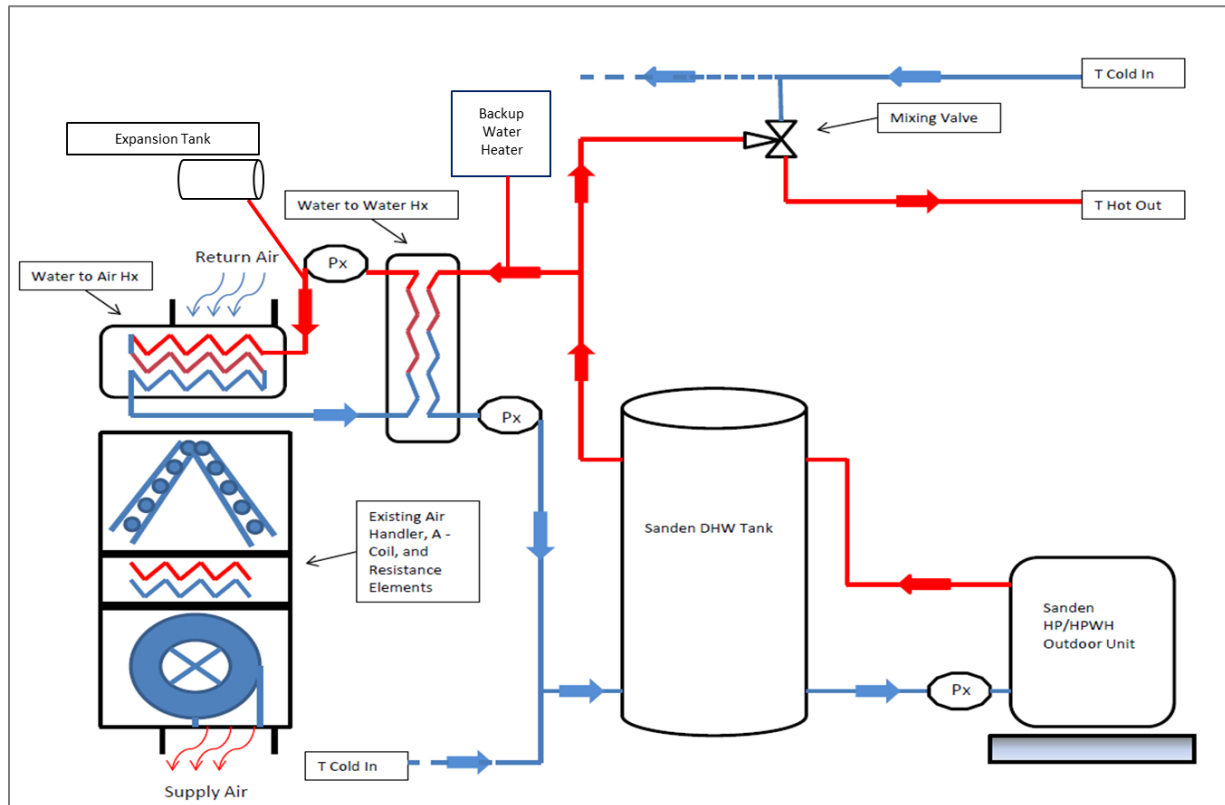

PNNL programs the temperature settings and DHW draws, and measures the resulting impacts through the network of sensors in each home. All data is recorded at 1-minute intervals.

The experiments found that in these relatively inefficient homes, the systems met average heating and DHW loads when OATs were 40°F or higher. When temperatures went below 40°F, space heating temperatures were maintained but DHW temperatures cooled below set point.

When space or water temperatures or hot water draws were increased significantly, the DHW temperatures were met as long as the OATs were 40°F or higher. When the heat pump was not allowed to operate in order to defer operation for oversupply mitigation at night, the space heat was maintained at set point, but the DHW temperature fell below 100°F throughout a test period where the OAT stayed between 20°F and 30°F most of the day.

When draw was increased from 46 GPD to 84 GPD, and the oversupply restrictions applied, both the space heat temperature and DHW temperatures dipped below set points.

The researchers identified three major findings:

1. The CO₂ system can work with a retrofit hydronic coil added to an existing FAF.
2. The efficiency of the home has a large impact on the ability of the system to meet space and hot water needs, and to perform oversupply mitigation service.
3. Moving the backup heater to the DHW line to maintain hot water delivery temperatures is indicated as a good solution.

The full report contains full descriptions and graphic portrayals of results. It can be found in Appendix B.

Conclusion

This research expanded the application of combined systems to existing homes, and added new equipment and different split system designs. It proved the concept of FAF conversion, which opens the door to hundreds of thousands of site-built and manufactured homes in the Pacific Northwest that could benefit from CO₂ refrigerant, hydronic heat pumps providing space and water heating.

The largest step forward was the lab and field testing of a higher-capacity CO₂ heat pump for cold climates, and higher load homes in milder climates. The Eco Runo demonstrated the ability to efficiently heat homes during a period with sufficiently cold temperatures to represent winter conditions in coastal and milder inland climates. These results promise that with optimization of the heat pump and the combined system, a new opportunity for energy-efficient space and water heating will open for many homes in the Pacific Northwest.

Split system CO₂ heat pumps demonstrated potential in existing homes with efficiency upgrades in climates ranging from Olympia, WA, to Nevada City, CA. The homes have been upgraded thermally to enable a 1.5 kW (input) heat pump to provide all space and water heating in these homes without backup. In each case, the design load of the home was within the output capacity of the heat pump.

The PNNL Lab Homes tests demonstrated that electric FAFs can be retrofitted with hydronic coils heated by CO₂ refrigerant, hydronic heat pumps.

Restricting heat pump operation to create capacity to absorb an oversupply of electrical generation at average space and water heating and use conditions does not of itself reduce the ability of the split system to deliver the same results as it would without the restriction taking place. To increase the performance range of the system in standard operation or oversupply mitigation, the thermal efficiency of the home must be increased to produce a design load within the capacity of the heat pump.

The region needs a working natural refrigerant solution for loads that are currently served by heat pumps using high global warming factor refrigerants. Amendments to the Montreal Protocol will begin the phase out of hydrofluorocarbon refrigerants beginning in 2018 worldwide, but action in the U.S. will lag. It is clear that CO₂ refrigerant will have to be promoted regionally. With ambitious plans being discussed in Vancouver B.C. and Seattle to convert natural gas furnaces to heat pumps, CO₂ refrigerant systems have great potential.

Recommendations

Progress raises questions and leads to new insights. This research is a beginning, but does not present final answers. WSU recommends the following based on the results of TIP 338:

1. Back-up heating should be applied to DHW temperature maintenance. The most frequent failure is hot water cooler than setpoint. It is also the most noticeable system failure to home occupants. The most economic means to provide this assistance is a demand electric resistance water heater that adds heat to boost the water temperature only when needed.
2. The design load of the home heated should be lower than the heat pump capacity at design temperature. This result was highlighted by the research at the PNNL Lab Homes.
3. Thermal retrofit to achieve proper design load for the hydronic heat pump is feasible and was done for four existing homes in the study. Further research into necessary retrofit levels is indicated.
4. Utilities and other efficiency organizations that are concerned about climate change should consider limiting incentives to equipment with low global warming potential (GWP) refrigerants—especially where the actions apply to a significant number of heat pumps. This will help shift the market to low GWP refrigerants faster than will otherwise take place in North America. See Appendix C for details.
5. To enable research into emerging technologies codes and code enforcement legislation need to be amended to provide for field testing of equipment that is listed in Europe or Asia when it represents an emerging technology that is being tested in the public interest as part of selecting and optimizing the technology for US distribution.

Ongoing Work

The field test of the DHP+ is continuing. The development of the prototype has been delayed due to circumstances beyond control of Mitsubishi, but the company remains committed to the workplan. NEEA is the main support for this research and BPA is continuing to contribute to system installation. A report on this technology will be available—probably in the next 18 months.

NEEA is continuing to support field research on the Eco Runo. The research includes homes with ER FAF and radiant slabs located in climates representing all three Pacific Northwest heating zones. A report will be available in the next 12 to 18 months.

BPA is providing resources to allow analysis of data from all the combined systems from TIP 326.

References

Davis, B and Robison D. (June, 2008). *High Efficiency Heat Pump Heating and AC Monitoring Project— Attachment 3 – Field Monitoring*. Prepared by Ecotope and Stellar Processes for the Idaho Office of Energy Resources as part of the State Technology Advancement Collaborative operated by the National Association of State Energy Officials.

Ecotope (April 2014). *Residential Building Stock Assessment: Metering Study*.
<http://ecotope.com/ecotope-publications-database/>

Ecotope and NEEA (March 2015). *Heat Pump Water Heater Model Validation Study*.
<http://neea.org/docs/default-source/reports/heat-pump-water-heater-saving-validation-study.pdf?sfvrsn=8>

Eklund, K. and Banks, A. (December 2015). *Advanced Heat Pump Water Heater Research Final Report – Technology Innovation Project 292*. Prepared by the Washington State University Energy Program.
http://www.energy.wsu.edu/Documents/Final%20Report%20TIP%20292_Dec%202015.pdf

Eklund, K. (September 2016). *Assessment of Demand Response Potential of Heat Pump Water Heaters Final Report*. Prepared by the Washington State University Energy Program.
<http://www.energy.wsu.edu/Documents/Final%20Report%20-TIP%20302%20-%20DR%20Assessment%20of%20CO2%20HPWH.pdf>

Eklund, K. and Banks, A. (September, 2016). *Combined Space and Water CO₂ Heat Pump System Performance Research*, Prepared by the Washington State University Energy Program.
<http://www.energy.wsu.edu/Documents/Final%20Report%20TIP%20326.pdf>

Larson, B. (September 2015). *Laboratory Assessment of Demand Response Characteristics of Two CO₂ Heat Pump Water Heaters*. A Report of BPA Technology Innovation Project #302. Prepared by Ecotope.

Larson, B., et al. (July 2015). *Laboratory Assessment of Combination Space and Water Heating Applications of a CO₂ Heat Pump Water Heater*. Prepared by Ecotope.

Larson, B. (September 2013). *Laboratory Assessment of Sanden GAU Heat Pump Water Heater*. A Report of BPA Technology Innovation Project #292. Prepared by Ecotope, Inc. for the WSU Energy Program under contract to BPA.
http://www.energy.wsu.edu/documents/Sanden_CO2_split_HWPH_lab_report_Final_Sept%202013.pdf

Sullivan, G. (July 2015). *Demand-Response Performance of Sanden HPWH*. Prepared by PNNL.

Thompson, M. and Kujak, S. (August 2016). *Merging the Transition to Next Generation HVAC Refrigerant Technology with Effective Climate Policy*. Proceedings ACEEE 2016 Summer Study in Buildings.
http://aceee.org/files/proceedings/2016/data/papers/3_406.pdf.

Appendix A: Laboratory Assessment

The *Laboratory Assessment of Eco Runo CO2 Air-to-Water Heat Pump*, August 2017, is provided as a link:

http://www.energy.wsu.edu/Documents/Sanden_EcoRuno_Lab_Test_Report.pdf

Appendix B: Pacific Northwest National Laboratory Report

The *CO2 Combination Space Conditioning and Water Heating Stress Tests in the PNNL Lab Homes*, September, 2017, is provided as a link: [http://labhomes.pnnl.gov/documents/PNNL-26462 Technical Report.pdf](http://labhomes.pnnl.gov/documents/PNNL-26462_Technical_Report.pdf)

Appendix C: Climate-Destroying Refrigerants

The Kyoto Protocol addressed the contributions to climate change of hydrofluorocarbons (HFCs) such as R-134a and R-410a. The European Union, Australia, and Japan have pioneered domestic reductions in HFC use. For example, HFCs are now banned for use in automotive air conditioners in the EU, and by 2030 the EU is targeting to produce only one-third of 2014 HFC emissions. In addition, in 2016 both the EU and North American countries submitted proposals to the Montreal Protocol to phase down the use of HFCs. The reason for these actions is shown in **Figure C-1** based on EPA information.

Figure C-1. Global Warming Potential of Refrigerants

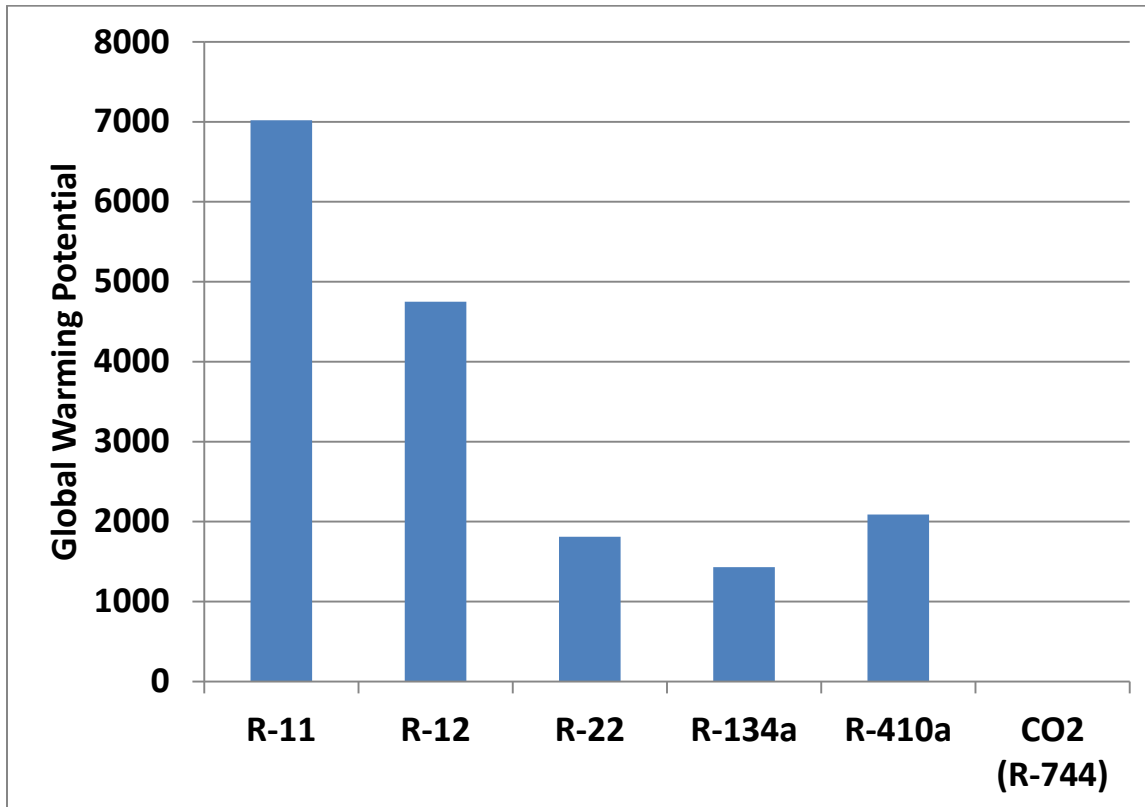

A pound of R-410a is equivalent to more than a ton of CO₂ in climate impact. And heat pumps normally leak up to 25% of their refrigerant per year, which usually result in service calls.

The problem is growing. Currently, the anthropogenic forcing from refrigerants is 1% to 2% of the total. With the growth in use of heat pumps and reductions in other sources of climate change, it is possible that if HFCs are not curbed, they will increase to 9% to 19% of the total by 2050 (Velders, et al., 2009, <http://www.pnas.org/content/early/2009/06/19/0902817106.abstract>).

The following graphic illustrates how the levels increase over time as the level of CO₂ emissions is brought under control while refrigerant use for air conditioning increases and technology spreads to developing nations. **Figure C-2** was taken from Merging the Transition to Next Generation HVAC Refrigerant Technology with Effective Climate Policy.

Figure C-2. CO₂ Levels Affected by HFC Scenarios

As

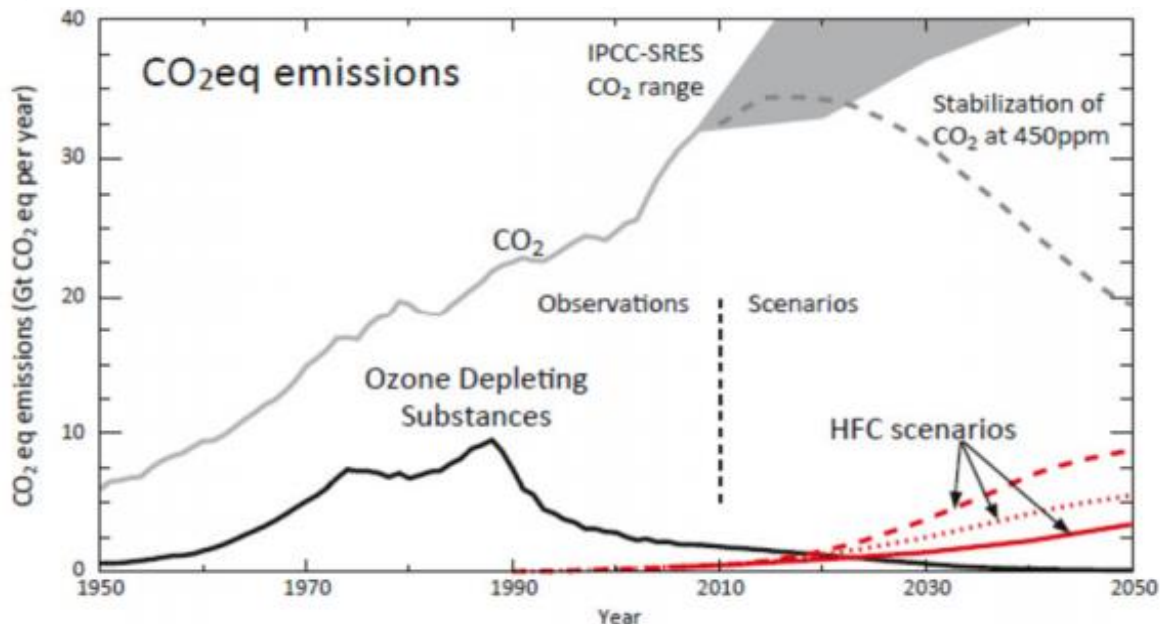

Ecotope stated in its 2016 lab test report: “Basically, carbon dioxide is an unusually environmentally friendly refrigerant. It is not toxic, flammable or corrosive, and it has no impact on the ozone layer. It is inexpensive and readily available (Austin and Sumathy, 2011). By definition, carbon dioxide has a GWP of one, as compared to 1,430 for R-134a or 2,100 for R-410a (U.S. EPA, 2015). There are essentially no fears of CO₂ being regulated out of existence for heat pump applications. If CO₂ can be utilized to provide comparable efficiency to an HFC-based heat pump, then it would be an ideal refrigerant to use.”

Sources Cited

Austin, B.; Sumathy, K., 2011. “Transcritical Carbon Dioxide Heat Pump Systems: A Review.” *Science Direct Renewable and Sustainable Energy Reviews* 15 (2011), pp. 4,013-4,029.
<http://users.ugent.be/~mvbelleg/literatuur%20SCHX%20-%20Stijn%20Daelman/ORCNext/Supercritical/Literature%20Study/Literature/Papers%20ORC/ORC%20Transcritical/2011%20-%20Austin%20-%20Transcritical%20carbon%20dioxide%20heat%20pump%20systems%20A%20review.pdf>

Velders, et al., 2009. “The Largest Contribution of Projected HFC Emissions to Future Climate Forcing.” *Proceedings of the National Academy of Sciences of the United States of America*, vol. 106, no. 27, pp. 10,949-10,954. <http://www.pnas.org/content/early/2009/06/19/0902817106.abstract>