

# **Performance Test Results: CTA-2045 HVAC Thermostat**

*Testing Conducted at the National Renewable Energy Laboratory*

**3002011747**

---



# **Performance Test Results: CTA-2045 HVAC Thermostat**

*Testing Conducted at the National Renewable Energy Laboratory*

**3002011747**

Technical Update, November 2017

EPRI Project Manager

C. Thomas

## **DISCLAIMER OF WARRANTIES AND LIMITATION OF LIABILITIES**

THIS DOCUMENT WAS PREPARED BY THE ORGANIZATION(S) NAMED BELOW AS AN ACCOUNT OF WORK SPONSORED OR COSPONSORED BY THE ELECTRIC POWER RESEARCH INSTITUTE, INC. (EPRI). NEITHER EPRI, ANY MEMBER OF EPRI, ANY COSPONSOR, THE ORGANIZATION(S) BELOW, NOR ANY PERSON ACTING ON BEHALF OF ANY OF THEM:

(A) MAKES ANY WARRANTY OR REPRESENTATION WHATSOEVER, EXPRESS OR IMPLIED, (I) WITH RESPECT TO THE USE OF ANY INFORMATION, APPARATUS, METHOD, PROCESS, OR SIMILAR ITEM DISCLOSED IN THIS DOCUMENT, INCLUDING MERCHANTABILITY AND FITNESS FOR A PARTICULAR PURPOSE, OR (II) THAT SUCH USE DOES NOT INFRINGE ON OR INTERFERE WITH PRIVATELY OWNED RIGHTS, INCLUDING ANY PARTY'S INTELLECTUAL PROPERTY, OR (III) THAT THIS DOCUMENT IS SUITABLE TO ANY PARTICULAR USER'S CIRCUMSTANCE; OR

(B) ASSUMES RESPONSIBILITY FOR ANY DAMAGES OR OTHER LIABILITY WHATSOEVER (INCLUDING ANY CONSEQUENTIAL DAMAGES, EVEN IF EPRI OR ANY EPRI REPRESENTATIVE HAS BEEN ADVISED OF THE POSSIBILITY OF SUCH DAMAGES) RESULTING FROM YOUR SELECTION OR USE OF THIS DOCUMENT OR ANY INFORMATION, APPARATUS, METHOD, PROCESS, OR SIMILAR ITEM DISCLOSED IN THIS DOCUMENT.

REFERENCE HEREIN TO ANY SPECIFIC COMMERCIAL PRODUCT, PROCESS, OR SERVICE BY ITS TRADE NAME, TRADEMARK, MANUFACTURER, OR OTHERWISE, DOES NOT NECESSARILY CONSTITUTE OR IMPLY ITS ENDORSEMENT, RECOMMENDATION, OR FAVORING BY EPRI.

**THE ELECTRIC POWER RESEARCH INSTITUTE (EPRI) PREPARED THIS REPORT.**

**This is an EPRI Technical Update report. A Technical Update report is intended as an informal report of continuing research, a meeting, or a topical study. It is not a final EPRI technical report.**

## **NOTE**

For further information about EPRI, call the EPRI Customer Assistance Center at 800.313.3774 or e-mail [askepri@epri.com](mailto:askepri@epri.com).

Electric Power Research Institute, EPRI, and TOGETHER...SHAPING THE FUTURE OF ELECTRICITY are registered service marks of the Electric Power Research Institute, Inc.

Copyright © 2017 Electric Power Research Institute, Inc. All rights reserved.

# ACKNOWLEDGMENTS

The Electric Power Research Institute (EPRI) prepared this report.

Principal Investigators

B. Seal

C. Thomas

This report describes research sponsored by EPRI.

This report describes research carried out at the National Renewable Energy Laboratory, under the INTEGRATE project Topic 1 focus area.

This report was developed based upon funding from the Alliance for Sustainable Energy, LLC, Managing and Operating Contractor for the National Renewable Energy Laboratory for the U.S. Department of Energy.

---

This publication is a corporate document that should be cited in the literature in the following manner:

*Performance Test Results: CTA-2045 HVAC Thermostat: Testing Conducted at the National Renewable Energy Laboratory.* EPRI, Palo Alto, CA: 2017. 3002011747.



## **ABSTRACT**

Utilities and manufacturers are assessing the CTA-2045 communication standard, published by the Consumer Technology Association (CTA) (previously Consumer Electronics Association (CEA)) to determine the degree to which it meets the needs of consumers, aggregators, and utilities. The Electric Power Research Institute (EPRI) is facilitating a collaborative project specifically studying the extent to which CTA-2045 provides compatibility and interoperability with the wide range of systems into which consumer loads might be connected. If a modular interface works as intended, achieving interoperability and being self-installable by consumers, it could significantly advance the state of demand response worldwide. One of these systems is an HVAC thermostat, and this report details laboratory evaluations of the system's capabilities.

### **Keywords**

CEA-2045

CTA-2045

HVAC

Thermostat

Smart grid

Demand response





# CONTENTS

<b>ABSTRACT .....</b>	<b>V</b>
<b>1 INTRODUCTION .....</b>	<b>1-1</b>
Device-Type Specific Requirements for CTA-2045 Devices.....	1-2
<b>2 HVAC THERMOSTAT .....</b>	<b>2-1</b>
Test Setup.....	2-1
Device Identification .....	2-3
Baseline Behavior .....	2-4
Visual Indicators.....	2-5
Shed Event.....	2-6
Critical Peak Event.....	2-7
Consumer Override.....	2-8



## LIST OF FIGURES

Figure 2-1 Thermostat Test Setup.....	2-1
Figure 2-2 Emerson Thermostat Tested at NREL .....	2-2
Figure 2-3 Thermostat and HVAC System .....	2-3
Figure 2-4 Communication Interface Showing Device Identification .....	2-4
Figure 2-5 Thermostat Baseline Behavior .....	2-5
Figure 2-6 Visual Indicators on Thermostat Display .....	2-6
Figure 2-7 Shed Event .....	2-7
Figure 2-8 Critical Peak Event.....	2-8
Figure 2-9 Consumer Override.....	2-9
Figure 2-10 Communication Interface Showing Consumer Override .....	2-10
Figure 2-11 Thermostat Displaying Consumer Override Status.....	2-10



# LIST OF TABLES

Table 1-1 Device-Type Specific Requirements..... 1-2



# 1

## INTRODUCTION

In 2013 the Consumer Electronics Association<sup>1</sup> (now called the Consumer Technology Association) released the ANSI/CEA-2045 standard. This standard defines a modular communication interface intended to be designed into end-use loads to enable demand response (DR). The CEA-2045 standard has been described in detail in EPRI report 3002004020, *Introduction to the CEA-2045 Standard*<sup>2</sup>.

Utilities and manufacturers are assessing this new standard to determine the degree to which it meets the needs of consumers, aggregators, and utilities. Electric Power Research Institute (EPRI) is facilitating a collaborative project that is specifically studying the extent to which CEA-2045 provides compatibility and interoperability with the wide range of systems into which consumer loads might be connected. If a modular interface works as intended, achieving interoperability and being self-installable by consumers, it could significantly advance the state of demand response worldwide. A detailed description of the CEA-2045 Field Demonstration project, including its goals and plan, has been provided in EPRI report 3002004009, *ANSI/CEA-2045 Field Demonstration Project Description*<sup>3</sup>.

In addition to the field demonstration described above, the EPRI and a team of partners were selected by the National Renewable Energy Laboratory (NREL) to carry out a project to develop and test how smart, connected consumer devices can act to enable the use of more clean energy technologies on the electric power grid. This project was a component of the NREL Integrated Network Test-bed for Energy Grid Research and Technology (INTEGRATE) initiative and was awarded under RFP Number RCS-4-42326, Topic 1, “Connected Devices”.

The project team includes the following end-use technologies and companies, each of which are market leaders in their fields. All of which were installed and tested at NREL’s Energy Systems Integration Facility (ESIF) in Golden Colorado.

- Electric Vehicle Service Equipment (Siemens)
- Thermostat (Emerson)
- Solar Inverter (Fronious)
- Pool Pump (Pentair)
- Water Heaters (AO Smith)

---

<sup>1</sup> Now known as the Consumer Technology Association.

<sup>2</sup> <http://www.epri.com/abstracts/Pages/ProductAbstract.aspx?ProductId=000000003002004020>

<sup>3</sup> <http://www.epri.com/abstracts/Pages/ProductAbstract.aspx?ProductId=000000003002004009>

## Device-Type Specific Requirements for CTA-2045 Devices

The end-use devices (loads) tested in this project were all designed using device-type specific requirements. These requirements and links to each document are listed in Table 1-1. The requirements were created through a collaborative effort by which utilities and technology providers participated. The intent of these requirements is to provide guidance by which manufacturers of end-use devices, communication hardware, and other service providers could use to help create a predictable, interoperable, data rich architecture.

**Table 1-1**  
**Device-Type Specific Requirements**

Document Name	EPRI Product ID
Demand Response-Ready Domestic Water Heater Specification, Preliminary Requirements for CEA-2045 Field Demonstration	<a href="#">3002002710</a>
Demand Response-Ready Thermostat Specification, Preliminary Requirements for CEA-2045 Field Demonstration	<a href="#">3002002711</a>
Demand Response-Ready Electric Vehicle Service Equipment Specification, Preliminary Requirements for CEA-2045 Field Demonstration	<a href="#">3002002712</a>
Demand Response-Ready Heat Pump Water Heater Specification, Preliminary Requirements for CEA-2045 Field Demonstration	<a href="#">3002002719</a>
Demand Response-Ready Variable-Speed Pool Pump Specification: Preliminary Requirements for CEA-2045 Field Demonstration	<a href="#">3002008320</a>

The tests were conducted at NREL to measure the performance characteristics of different end-use devices and their potential to support renewable resource integration can. This report includes the results from the HVAC thermostat tests.



# 2

## HVAC THERMOSTAT

This document presents the test results from the Emerson programmable thermostat. Testing was performed at EPRI and at NREL during a series of onsite visits by team members.

The test plan that guided this testing has been documented separately.

### Test Setup

Figure 2-1 shows the test setup used for the thermostat testing at NREL.

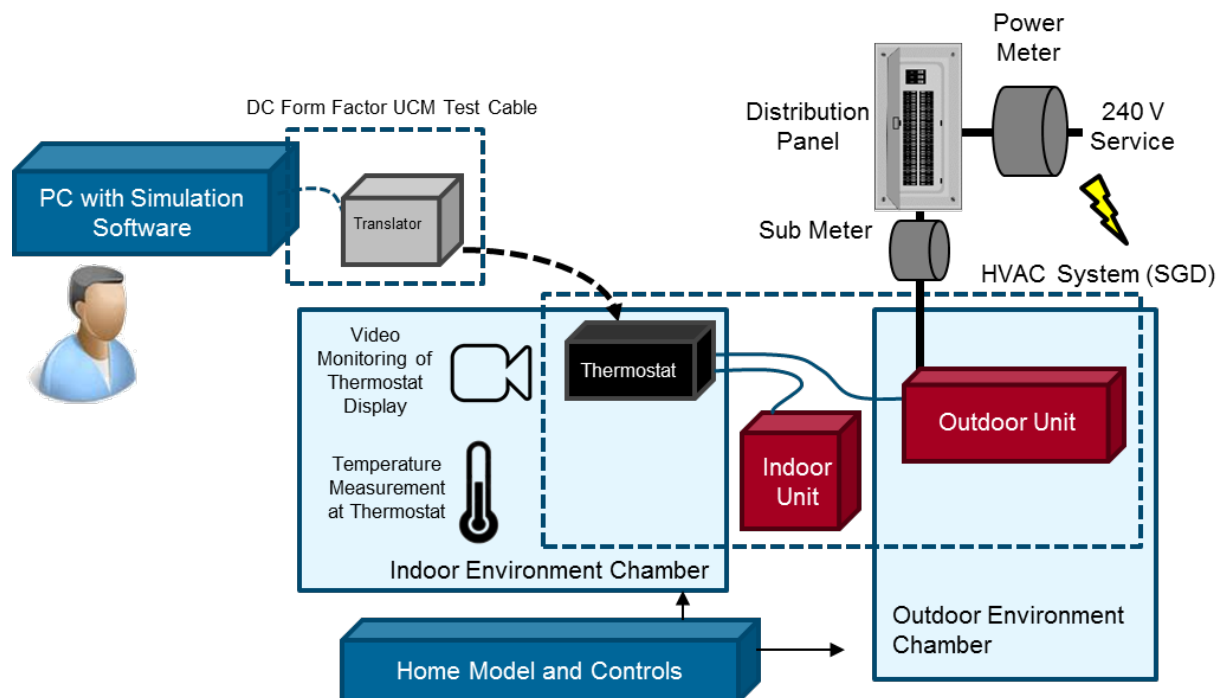

**Figure 2-1**  
**Thermostat Test Setup**

A single thermostat was tested. All testing was conducted using a normal grid connection feeding the AC circuit. The NREL laboratory SCADA system included the following sensors and controls that were used in this test:

- Real power consumption of the HVAC system.
- Temperature at the thermostat (indoor chamber)
- Temperature at the outdoor unit (outdoor chamber)

In addition, EPRI monitored the following directly from the thermostat using the CEA-2045 Simulator software:

- Present power consumption
- Cumulative energy consumption
- Present operating state
- Consumer override

**Figure 2-2** shows the thermostat used in the laboratory testing at NREL.



**Figure 2-2**  
**Emerson Thermostat Tested at NREL**

Figure 2-3 shows the thermostat positioned in the indoor environment chamber during testing (right) and the compressor/condenser unit in the outdoor environment chamber for testing.



**Figure 2-3**  
**Thermostat and HVAC System**

### **Device Identification**

As indicated in Figure 2-1, the EPRI CEA-2045 Simulator software was used to communicate with the thermostat, monitoring its status and managing its behavior throughout the test. This software is designed to plug-in directly to the CEA-2045 port interface at which communication modules would normally be connected.

The unit's identification was queried and reported as indicated in Figure 2-4. This includes a device-type code indicating "Central AC – Heat Pump", as well as a unique vendor ID, serial and revision numbers.



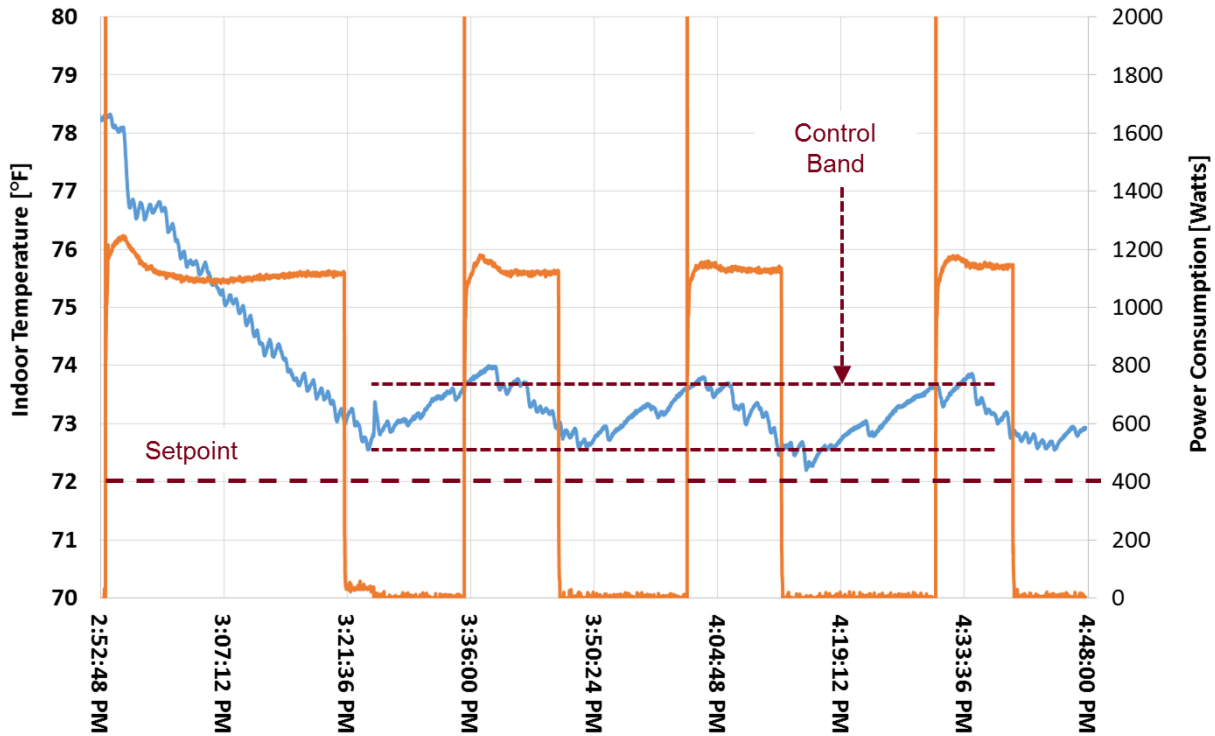

**Figure 2-5**  
**Thermostat Baseline Behavior**

It is noted from the test results that the modeled system includes inertia in relation to the HVAC operation. The temperature at the thermostat continues to move in the same direction for about 2-3 minutes after the system turns on or shuts off.

Data captured using the EPRI communication simulator indicated that the thermostat reported operating states of “Idle Normal” when not running and “Running Normal” when operating during this test.

The thermostat reported power consumption of 0 [Watts] when not running and 2200[Watts] when running, the Emerson population average value. These values were reported at the same two levels during the remaining test steps.

### Visual Indicators

The thermostat included visual indicators related to grid control on the display as shown in Figure 2-6.

**Event Status:** Indicated in a text field at the top of the thermostat.

**Event End Time:** If provided in the event message by the control system, this indicator is illuminated when a control or event is in effect that alters the thermostat’s normal mode of operation in any way.

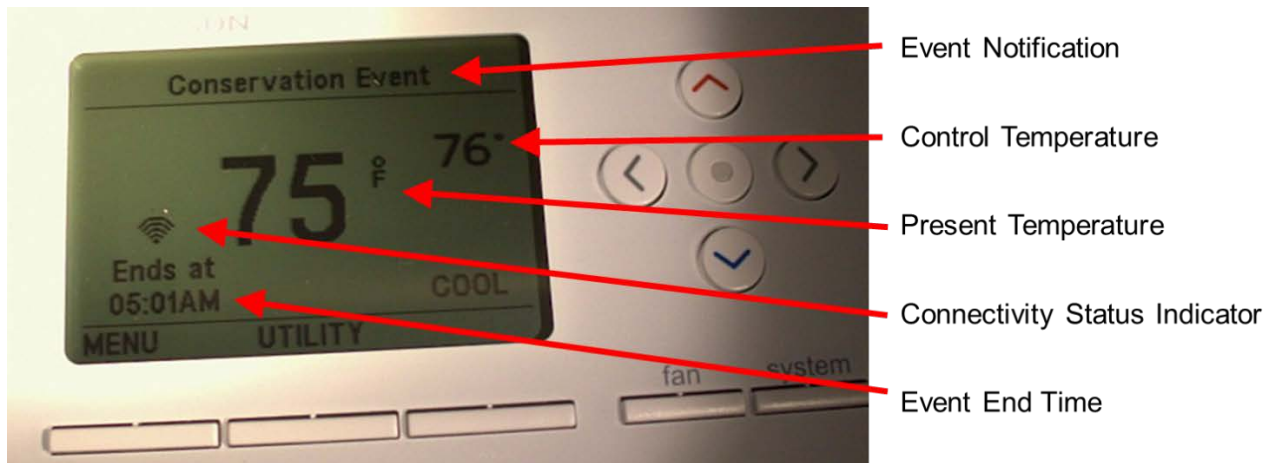

**Figure 2-6**  
**Visual Indicators on Thermostat Display**

### Shed Event

The results from the testing of the thermostat’s basic “Shed” function are summarized in Figure 2-7.

As noted from the test times, this shed test immediately followed the baseline test described in the preceding section. The environmental chamber control system was restarted due to issues unrelated to the thermostat testing, resulting in the rise in control chamber temperature seen at the left of the chart.

The Shed event was issued at 5:15PM as indicated and remained in effect through the remainder of the test period. The HVAC system was operating when the Shed event was initiated and it immediately turned off.

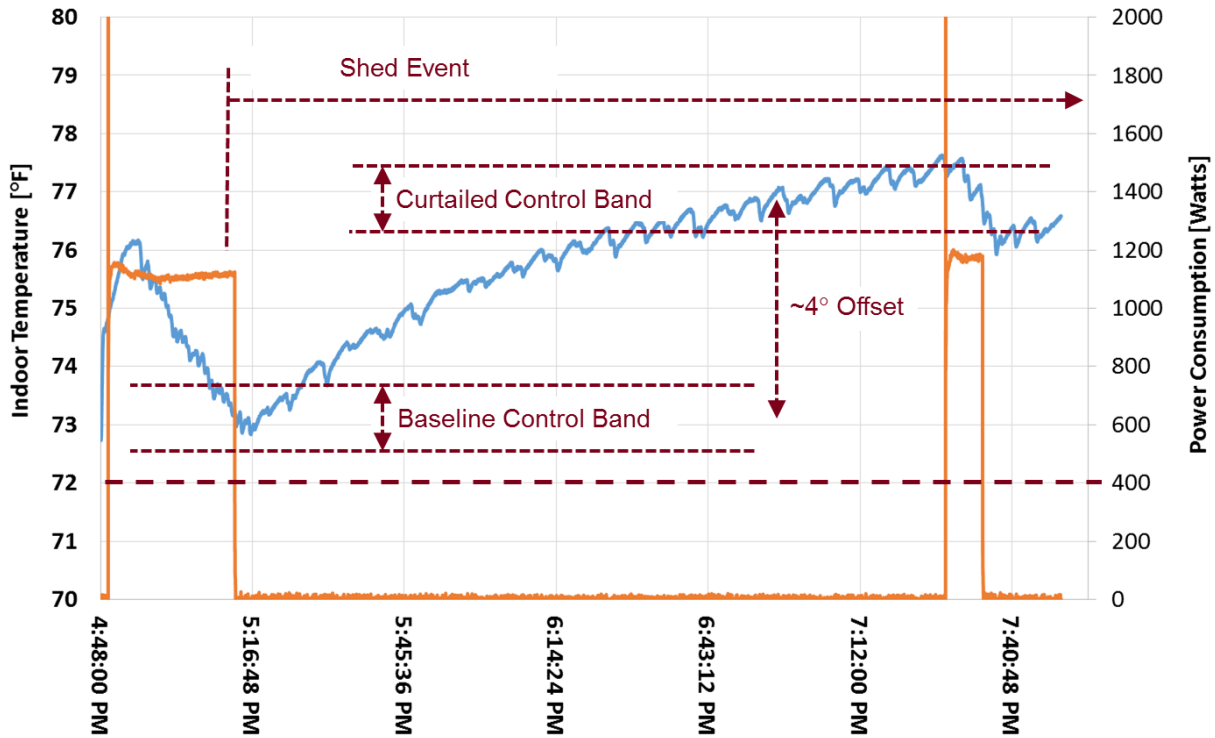

**Figure 2-7  
Shed Event**

The thermostat’s intended response to a Shed event is to offset the control temperature by 4[°F] (+4 when in cooling mode, -4 when in heating mode). The test data indicates such a response, with the control band remaining approximately the same width (1.5[°F]) but shifted.

With the home model utilized in this test, this resulted in a 2:15 hour delay of operation, from 5:15PM until 7:25PM.

Data captured using the EPRI communication simulator indicated that the thermostat reported operating states of “Idle Grid” when not running and “Running Curtailed Grid” when operating during the Shed event.

The Shed test was terminated at 7:50PM.

### **Critical Peak Event**

The results from the test of the thermostat’s “Critical Peak” function are summarized in Figure 2-8. Note that this chart covers a longer period of time than those in Figure 2-5 and Figure 2-7

This test was started at 7:48AM and the thermostat ran in normal operating mode until the Critical Peak event was issued at 9:08AM. During this normal operation period, the unit operated in the same fashion as the baseline, cycling on and off and regulating the temperature with a control band (dead band) of about 1.5[°F] centered at ~73[°F].

The unit was operating when the Critical Peak event was initiated. It shut off immediately and remained off until ~2:50PM until the indoor temperature had risen to ~81[°F].

The thermostat’s intended response to a Critical Peak event is to offset the control temperature by 8[°F] (+8 when in cooling mode, -8 when in heating mode). The test data indicates such a response, with the control band remaining approximately the same width (1.5[°F]) but shifted.

With the home model utilized in this test, this resulted in a ~5:40 hour delay of operation, from 9:08AM until 2:50PM.

Data captured using the EPRI communication simulator indicated that the thermostat reported operating states of “Idle Grid” when not running and “Running Curtailed Grid” when operating during the Critical Peak event.

After the offset temperature was reached, the unit cycled on/off as expected until the Critical Peak event was terminated by sending a “Run Normal” message at 3:25PM. Following the event, the unit operated continuously until the temperature was back to the normal operating range.

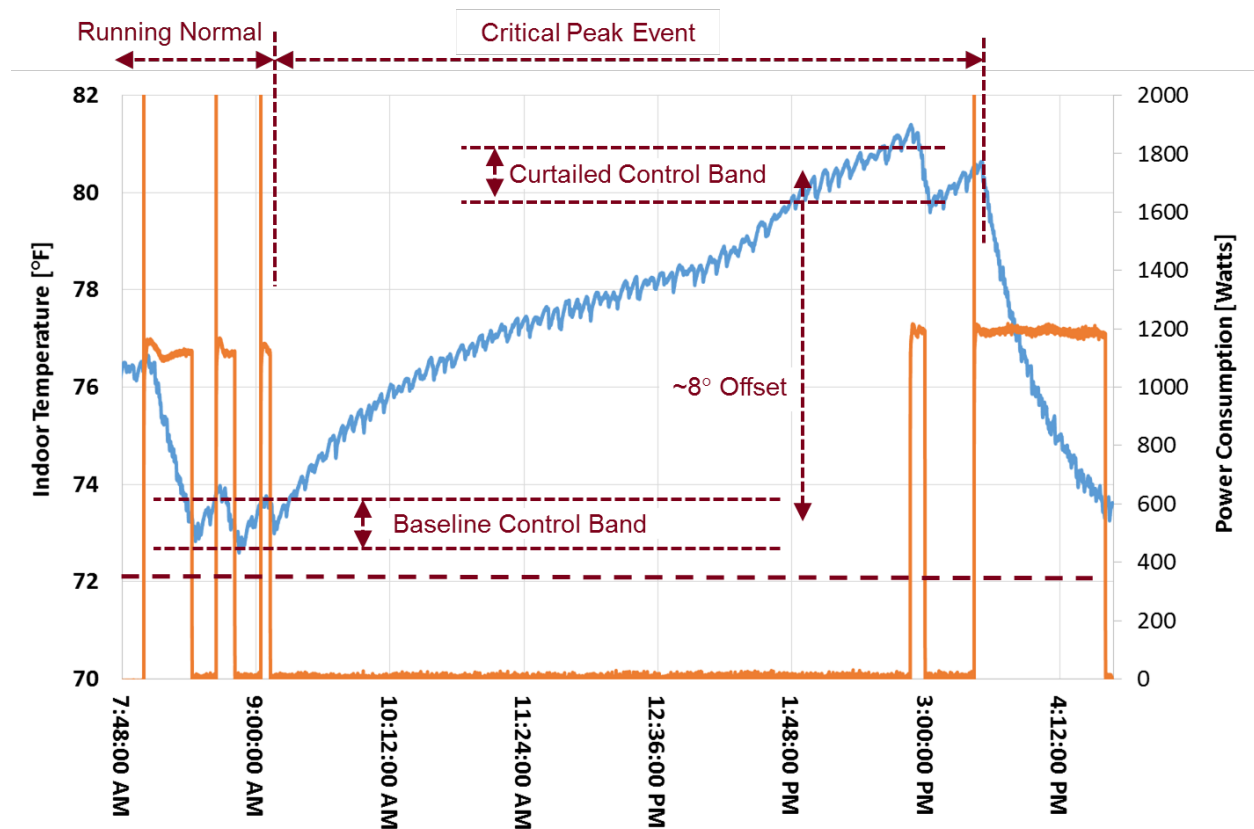

**Figure 2-8**  
**Critical Peak Event**

### Consumer Override

Although not a functional requirement in terms of enabling more solar generation on the grid, consumer override is considered a required feature in order to ensure that the consumer is in control and to encourage program participation.



The results of the consumer override test are summarized in Figure 2-9. This test was performed immediately following the Critical Peak test describes in the previous section.

Following recovery to the normal temperature range, another Critical Peak event was issued at 4:40PM. In this case, the HVAC system was in an off state when the Critical Peak event was initiated. The unit stayed off and the temperature began to rise.

If left in this state, the temperature would have risen to an 8 degree offset as in the previous section. At 4:53PM, a Consumer Override was initiated by pressing the button on the thermostat. The door to the indoor environmental chamber was quickly opened to perform this action. At this time, the temperature had risen to 75[°F], well above the normal control band.

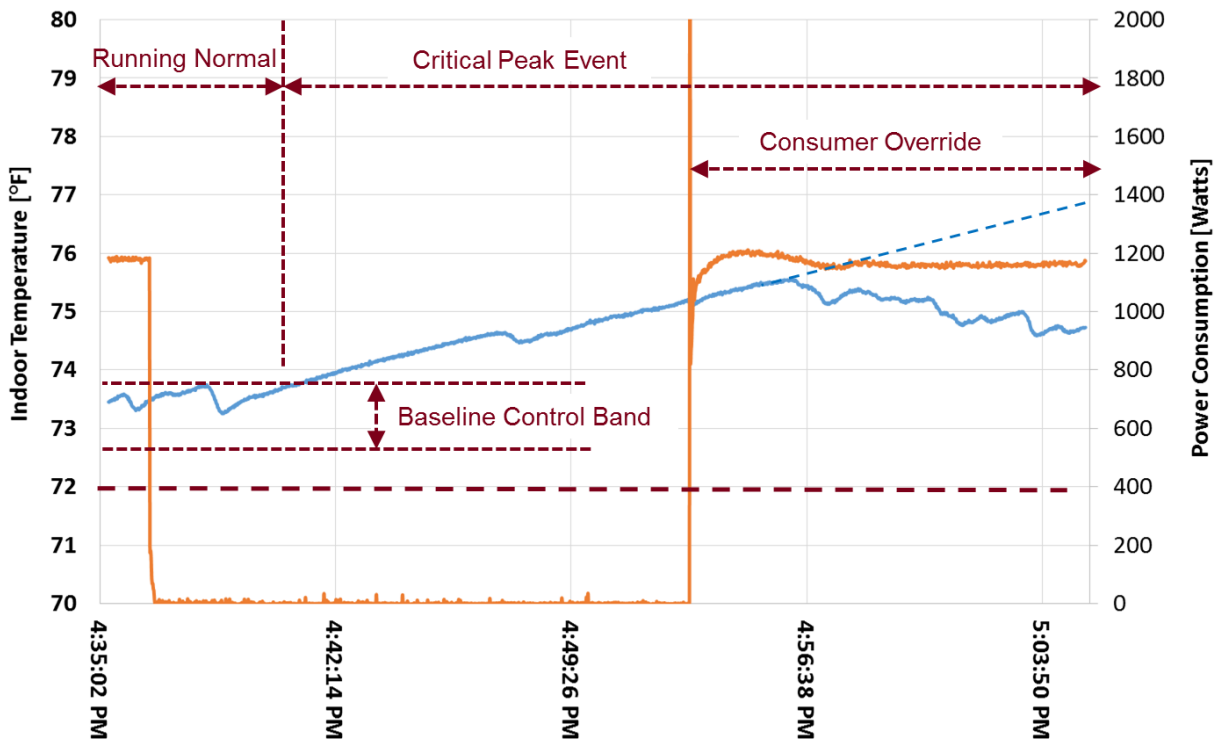

**Figure 2-9**  
**Consumer Override**

When the Consumer Override was initiated, the unit immediately turned on and operated as when running normally. The operating state was reported as “Running Normal” when on and during this period because the event was no longer being honored.

Immediately upon initiating the Consumer Override, the thermostat sent an unsolicited notification over the communication interface as indicated in Figure 2-10.

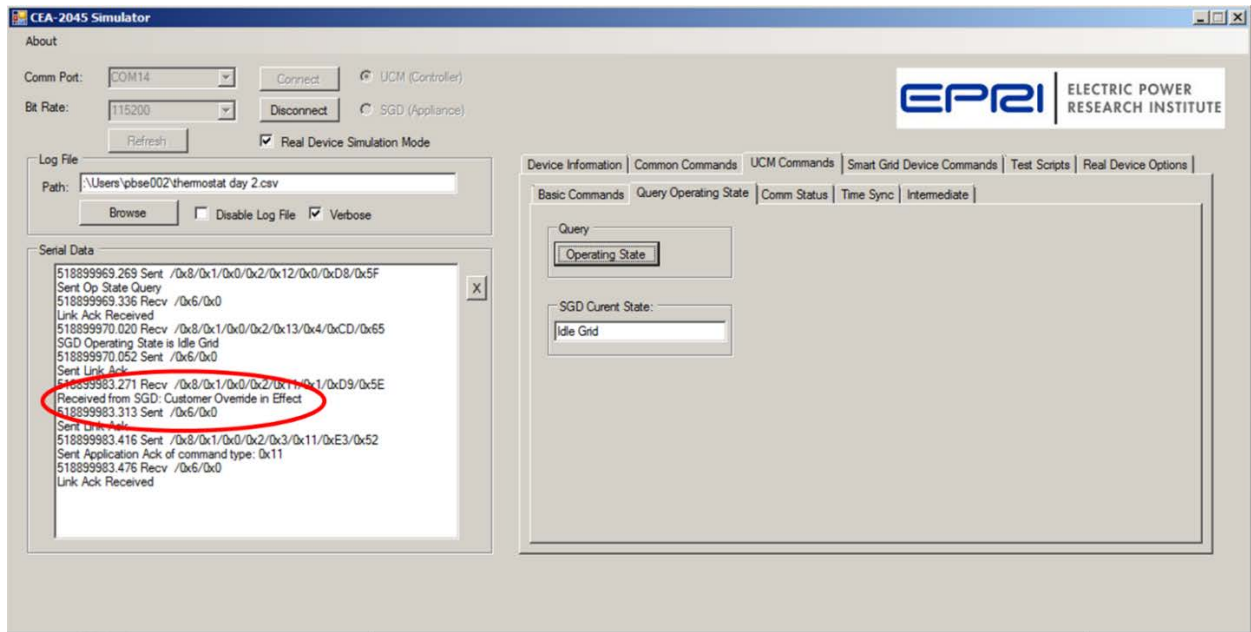

**Figure 2-10**  
**Communication Interface Showing Consumer Override**

In addition, the thermostat displayed the override status in the text notification field as shown in Figure 2-11.

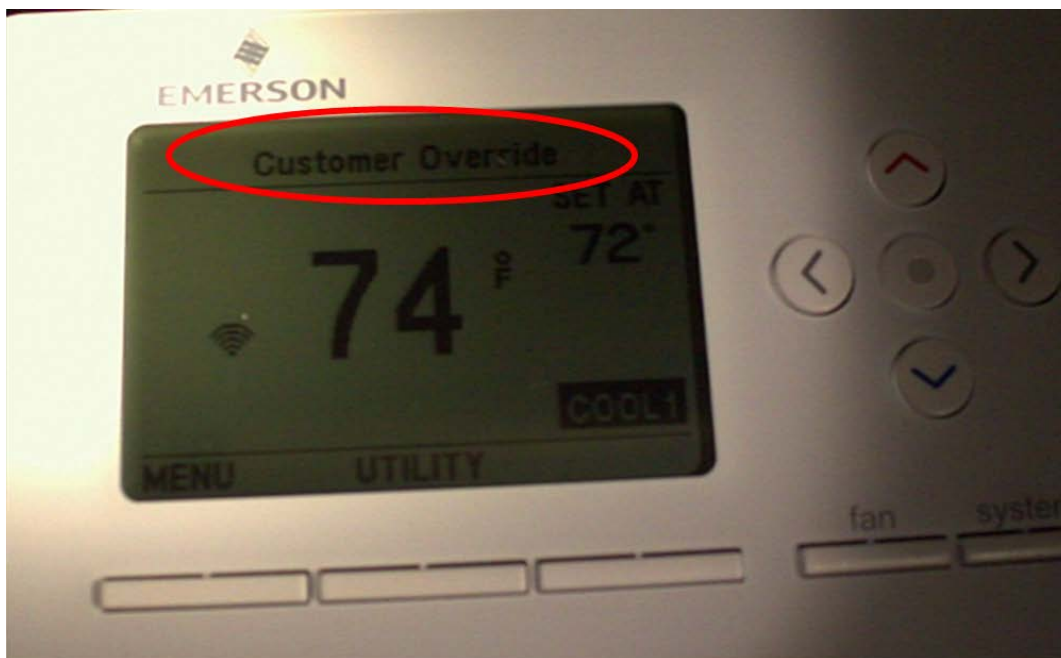

**Figure 2-11**  
**Thermostat Displaying Consumer Override Status**



**The Electric Power Research Institute, Inc.** (EPRI, [www.epri.com](http://www.epri.com)) conducts research and development relating to the generation, delivery and use of electricity for the benefit of the public. An independent, nonprofit organization, EPRI brings together its scientists and engineers as well as experts from academia and industry to help address challenges in electricity, including reliability, efficiency, affordability, health, safety and the environment. EPRI members represent 90% of the electric utility revenue in the United States with international participation in 35 countries. EPRI's principal offices and laboratories are located in Palo Alto, Calif.; Charlotte, N.C.; Knoxville, Tenn.; and Lenox, Mass.

Together...Shaping the Future of Electricity

© 2017 Electric Power Research Institute (EPRI), Inc. All rights reserved.  
Electric Power Research Institute, EPRI, and TOGETHER...SHAPING THE  
FUTURE OF ELECTRICITY are registered service marks of the Electric  
Power Research Institute, Inc.

3002011747