

Advanced Heat Pump Water Heater Research Final Report

Bonneville Power Administration
Technology Innovation Project 292

Organization

Washington State University –
WSU Energy Program in Olympia, WA

Co-Sponsors

Avista Corp.
The Energy Trust of Oregon
Northwest Energy Efficiency Alliance
Ravalli Electric Co-op
Tacoma Public Utilities

Prepared by

Ken Eklund and Adria Banks, WSU Energy Program
Ben Larson, Ecotope, Analysis Consultant and Reviewer
360-956-2019, eklundk@energy.wsu.edu



Publication Date: December 31, 2015

WSUEEP15-022

A Technology Innovation Project Report

The research described in this report was funded by Bonneville Power Administration (BPA) to assess the potential for emerging technologies and provide for development of those technologies to increase the efficiency of electricity use and provide other benefits such as capacity reduction and demand response services. BPA is undertaking a multi-year effort to identify, assess and develop emerging technologies with significant potential for contributing to the goals of efficiency, capacity reduction, demand-response and climate change remediation.

Neither WSU nor BPA endorse specific products or manufacturers. Any mention of a particular product or manufacturer should not be construed as an implied endorsement. The information, statements, representations, graphs, and data presented in these reports are provided as a public service. For more reports and background on BPA's efforts to "fill the pipeline" with emerging, energy-efficient technologies, visit Energy Efficiency's Emerging Technology (E3T) website at http://www.bpa.gov/energy/n/emerging_technology/.

Ken Eklund is the Building Science and Standards Team Lead for the Washington State University Energy Program (WSU). His background includes research organization and management spanning forty years in the energy efficiency field. His work at WSU includes facilitation and coordination of staff involved in building science research, and in development and implementation of research projects like the current one that leverages the experience and capabilities of WSU staff and of skilled subcontractors-all blended into a collaborative team.

Acknowledgements

This project was greatly helped by the management of Kacie Bedney Rossman, the initial BPA Project Manager and COTR for this research and this report is dedicated to her. After her retirement, the roles were ably taken by Janice Peterson, Project Manager and Stephanie Vasquez, COTR. Matt DeLong, CO for this project was also a great resource in smoothing the business and contracting end of the project. WSU staff David Hales, monitoring expert, and Adria Banks, analyst, were key to the project success together with Ecotope's Ben Larson and Michael Logsdon. Ben managed the lab test at Cascade Engineering Services and analyzed and reported the data. Kumar Banerjee managed the details of the lab test and hosted a memorable lab tour. Thanks also to the utility partner representatives: Bruce Carter, Tacoma Power; Fred Gordon, ETO; Jim Maunder, Ravalli Electric Coop; and Tom Lienhard, Avista. And finally, to Dave Kresta at NEEA for his support, and to the Advisory Task Force for guidance.

Abstract

The CO₂ refrigerant, split-system heat pump water heater was tested in both lab tests and at four field sites representing the three heating zones in the Pacific Northwest. This report focuses on the field tests and the data and experience collected over almost two years of monitoring. This is a promising technology. The field tests demonstrated that the promise of the lab tests was carried out in the field, and that this technology has great promise as an efficient water heater in all climates of the Pacific Northwest.

Contents

Executive Summary	1
Introduction	2
CO₂ Refrigerant System Operation	3
Research Overview	5
Project Organization	6
Lab Test	7
Description	8
Site Summaries	8
Field Study Design.....	9
Description of Analysis	11
Comparing Heat Pump Water Heaters – Energy Use per Unit of Hot Water	11
Energy Factor vs. Coefficient of Performance	11
Challenges in Monitoring	12
Analysis Protocols	13
Issues Addressed and Lessons Learned	14
OSA Temperature.....	14
Freeze Protection.....	15
Temperatures.....	17
Tank Room Summaries (from Metered Readings)	17
Household Water Temperatures (from Flow Event Averages).....	17
Tempered Water Temperature and Use	20
Billing Analysis.....	22
Survey Results	23
System Performance	24
Montana Baseline Testing.....	26
Portland Line Clog and Impact on System Efficiency	28
Multiple Regression Analysis	29
Field Energy Factors	29
Benefit-to-Cost Analysis and Climate Change Impact	33
Cost-Effectiveness for Efficiency Value Only	33
Cost-Effectiveness Considerations.....	33
Conclusions	35
Recommendations	36
References	37

Tables

Table 1. Summary of Results.....	7
Table 2. Heating Zones of Four Test Sites	9
Table 3. Test Site Characteristics	9
Table 4. Low, Average, and Standard Deviation from Average OAT at Each Site.....	15
Table 5. Survey Results	23
Table 6. Average Electrical Usage per Gallon for the HPWH versus the ERWH in Montana.....	27
Table 7. Average Weekly FEF for Each Site	30

Figures

Figure 1. Comparison of CO ₂ and Standard Refrigerant Operation.....	3
Figure 2. Impact of Operating at Optimum Temperature	3
Figure 3. HPWH System Components – Outdoor Unit and Insulated Water Tank.....	4
Figure 4. Sanden System Schematic	4
Figure 5. Field Monitoring Setup	10
Figure 6. Daily Average Temperature at Each Site through July 2015.....	14
Figure 7. Heat Tape Energy Use	16
Figure 8. Temperature of Space Surrounding the Tank.....	17
Figure 9. Average Cold Water Supply Temperatures at Each Site	18
Figure 10. Average Hot Water Output Temperature by Site	19
Figure 11. Average Delivered Water Temperature Selected by Homeowners	20
Figure 12. Daily Average Hot Water Use	21
Figure 13. Seasonality of Energy Use at Each Site	22
Figure 14. Model Residuals after Accounting for Weather over Billing Period	23
Figure 15. Water Flow through the Hot Water System and Energy Used to Heat It.....	25
Figure 16. Hourly Water Use and HPWH Power Draw for Each Site	26
Figure 17. Water Flow Diversion into the HPWH or ER Tank – Montana Site.....	27
Figure 18. Portland System Performance Before and After Filter Cleaning	28
Figure 19. Clogged Filter at Portland Site	29
Figure 20. Weekly FEF (Excluding Freeze Protection) and Temperature – All Sites	30
Figure 21. Energy Factor for Various Test Temperatures	31
Figure 22. Weekly FEF (Excluding Freeze Protection) and Temperature – All Sites with Lab Test Slope ...	31
Figure 23. Weekly FEF (Excluding Freeze Protection and Temperature – per Site)	32
Figure 24. Relative Global Warming Potential of Common Refrigerants	34

Abbreviations

AC	alternating current
BPA	Bonneville Power Administration
CO ₂	carbon dioxide
COP	coefficient of performance
DOE	U.S. Department of Energy
EF	energy factor
ER	electric resistance
ERWH	electric resistance water heater
FEF	Field Energy Factor
GWP	Global Warming Potential
HDD	heating degree days
HPWH	heat pump water heater
HFC	hydrofluorocarbons
OAT	outside air temperatures
OSA	outside air
PSI	pound per square inch
UL	Underwriters Laboratory
WSU	Washington State University

Executive Summary

This report is for Technology Innovation Project 292 conducted by Washington State University (WSU) and funded by Bonneville Power Administration (BPA). The project was to conduct lab and field studies of the Sanden model # GAU-A45HPA heat pump water heater (HPWH), analyze and report the results.

The equipment studied is a CO₂ refrigerant, split system HPWH, and these were the first extensive lab and field tests of this technology in the Pacific Northwest. The project began in October 2012 and culminated at the end of 2015 with this final report.

The lab test was reported in a separate document by Ecotope, Inc. on September 18, 2013. The results are summarized briefly in this report. That work provided the basis for the field test that followed. That test had four sites, each with at least four occupants, and began with an installation in Tacoma, Washington followed by the installation in Montana in the fall of 2013 and installations in Addy, Washington and Portland in early 2013. Field data was collected for over a year at all sites.

The format and content of this report was developed in the context of two interim reports called the Midterm Field Study Reports. These reports provided the means to develop the analytical tools and methods, articulate the processes and preliminary findings and obtain BPA and Advisory Task Force feedback on all of these as well as format and content.

The findings are of two types: The primary one is the measured performance of the equipment, and the secondary findings are the operational challenges of the equipment and monitoring it. The primary findings are:

- The HPWH are capable of heating water for families as large as seven persons in all Pacific Northwest climates without backup electric resistance heat.
- The average performance of the systems in the field is comparable to the field test results.
- The long term field energy use to heat water is .05 kWh per gallon—compared to an average .2 kWh per gallon for electric resistance water heaters (ERWH) and .1 kWh per gallon for standard HPWH.
- The systems can be cost-effective if installation is efficient and markups are reasonable.

The secondary findings are:

- Systems must have US plumbing and electrical fittings.
- Freezing of the outdoor unit and the plumbing lines going to and from it is possible during periods of power outage and freezing conditions, and the systems must be designed and installed to deal with this possibility.
- Heat tape used to protect lines must be specified carefully and installed properly to avoid severe energy penalties on the systems.
- Clogging of filters may be caused by debris in water supply systems, and should be pre-emptively dealt with by installers in areas with this problem and addressed in the installation manual.

Introduction

This is the final report on research by Washington State University (WSU) Energy Program into the performance of advanced heat pump water heaters (HPWHs). The research is funded by the Bonneville Power Administration (BPA) through its Technology Innovation Program (TIP).

These water heaters are unique for three significant reasons:

- First, they are split systems, meaning the compressor and evaporator are separate from the hot water tank, and take heat from outside air (OSA) without impacting the conditioned space or creating internal noise – both of which are issues with unitary HPWHs currently available in the U.S. market.
- Second, the compressor, fan, and pump use a highly efficient variable speed, inverter-driven technology unlike most of the HPWHs on the market.
- Third, they have carbon dioxide (CO₂) as the refrigerant. CO₂ has higher performance than standard refrigerants in this application and a significantly lower impact on the environment.

The environmental benefit of using CO₂ as a refrigerant is that its Global Warming Potential (GWP) is 1. This compares very favorably to the refrigerants in most HPWHs, which are hydrofluorocarbons (HFCs) with GWP several orders of magnitude higher than CO₂. The use of CO₂ as a refrigerant was introduced in response to climate change in Japan, and is now being used in Europe and Australia for environmental reasons. The equipment being tested in this study is manufactured by Sanden International in Australia.

The research began with a lab test, which was done by Ecotope, Inc. of Seattle and Cascade Engineering Services, a lab in Redmond, Washington. This report, [Laboratory Assessment of Sanden GAU Heat Pump Water Heater](#) (Larsen, 2013), demonstrates the potential of the technology with energy factors significantly higher than unitary systems located inside conditioned space or sheltered in buffer spaces, like basements and garages, which draw heat from conditioned space.

The question of whether the lab performance would translate to actual use is answered by the field study. In this phase of the research, local plumbers and electricians installed the systems in four single-family homes so the researchers could measure performance in real world conditions. Performance was measured according to protocols used for similar studies of unitary systems. See, for example, the [Heat Pump Water Heater Field Study Report](#) (Fluid Market Strategies and NEEA, 2013). Surveys of water use and occupants' response to the systems were also conducted.

Information from this research has been used to prepare a product for sale in the U.S. Lab and field tests have produced practical information that is helpful in the design process to adapt an Australian product for use in colder climates. These changes, together with third-party lab and field testing, have been useful in obtaining listing by Underwriters Laboratory (UL).

This report covers the entire project, which began October 1, 2012 and continued to final report delivery in December 2015. It includes the journey in understanding the potential of this game-changing technology from a lab test of this technology's unknown potential to a dynamic field study that tested its performance under actual use conditions.

CO₂ Refrigerant System Operation

The systems used in the field study heat water from the cold water supply temperature to 149°F in a single pass. This thermal lift is a characteristic of CO₂ systems that results from the heat capacity of CO₂ at a specific operating pressure, and is an important contributor to the efficiency of these systems and their ability to extract heat from OSA at low temperatures.

Figure 1¹ compares the operation of CO₂ and standard refrigerants in terms of their state, temperature, pressure, and total energy (specific enthalpy). CO₂ operates in a transcritical cycle at a pressure of ≈75 bar or 1,087 pounds per square inch (PSI) on the high-pressure side. The CO₂ is in the transcritical phase at the refrigerant to water heat exchanger. This phase is called gas cooling and the CO₂ is not discernably in either a liquid or gas phase – it has attributes of both. After it leaves the gas cooler, it drops down into the evaporator at a lower pressure and temperature where it absorbs heat from the ambient air as it changes state from a liquid/vapor mixture to a super-heated gas. The compressor then lifts the CO₂ back to the transcritical zone where it transfers heat to the colder water.

Figure 1. Comparison of CO₂ and Standard Refrigerant Operation

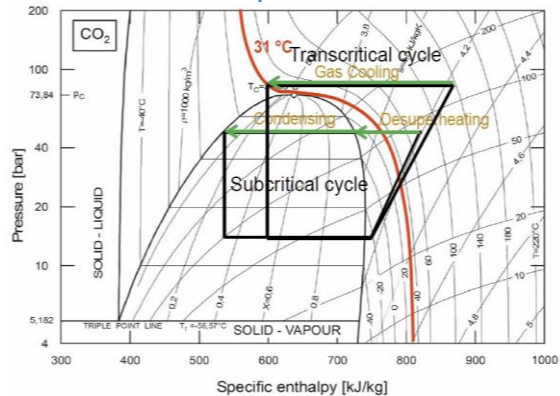

The impact of operating at the optimum temperature and pressure at the evaporator is shown in **Figure 2**. The specific heat at 75 bars is significantly greater than that of CO₂ gas at other pressures. This allows CO₂ to move more heat at low temperatures, and requires great engineering skill in system design to maintain.

Figure 2. Impact of Operating at Optimum Specific Heat

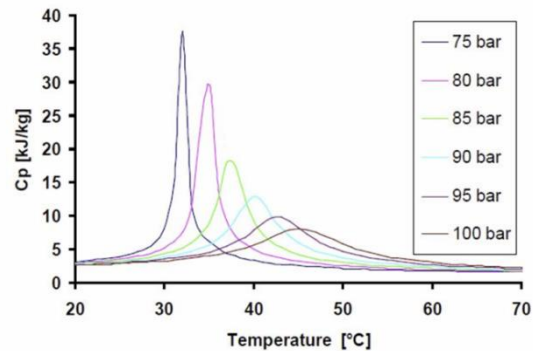

Every CO₂ system must work with pressures higher than for conventional refrigerants. In the systems used for this research project, the manufacturer has isolated the CO₂ charged components, and the charged system is serviced only by the manufacturer.

This design is approved in Japan, China, Australia, and Europe. UL listing for the U.S. is currently in process. The manufacturer, which builds one-third of the world's vending machines and most automotive compressors, already has UL listing for a vending machine cooling compressor using CO₂, and Coca Cola is currently changing all of its vending machines worldwide to use CO₂ refrigerant.

¹ Figures 1 and 2 are from Rolf Christensen at Alfa Laval, a manufacturer of advanced heat exchangers used with CO₂ and other heat exchange fluids, and are used with permission. The terms used are metric, but are shown here for the relative and relational aspects they reveal about the physics of CO₂ refrigerant.

The subject of this research is a split system heat pump, meaning that its functions are separated into two different parts. The compressor, air-to-CO₂ and CO₂-to-water heat exchangers, control system, and circulation pump are all located in the outdoor unit. The heat storage is an insulated water tank that is located inside conditioned space. The tank has a sensor that measures the tank temperature at a height about two-thirds from the bottom of the tank. When the water temperature at that location drops to 113°F, the outside unit activates. The tank does not have backup heating elements like most HPWHs.

The two components are connected by hot and cold water lines and a sensor wire. Cold water is pumped from the bottom of the tank into a heat exchanger at the base of the outdoor unit, where heat is transferred from heated CO₂ gas via a heat exchanger called a gas cooler. The heated water returns to the top of the tank. **Figure 3** is a photograph of the system.

Figure 3. HPWH System Components – Outdoor Unit and Insulated Water Tank



A sensor wire connects the tank temperature sensor to the control system in the outdoor unit. The controls turn the system on and off for water heating, operate the defrost cycle to prevent icing in cold weather, and circulate hot water to prevent freezing of the lines and heat exchanger during long periods of system inactivity in cold weather.

The water lines are equipped with heat tape by the system installer. Installation also requires providing power to the outdoor unit, running water and sensor lines between the outdoor unit and tank, insulating the water lines, and connecting the tank to household water supply and distribution piping. A mixing valve to temper the hot water to a safe temperature is required. **Figure 4** shows the system in a schematic from the Sanden brochure.

Figure 4. Sanden System Schematic

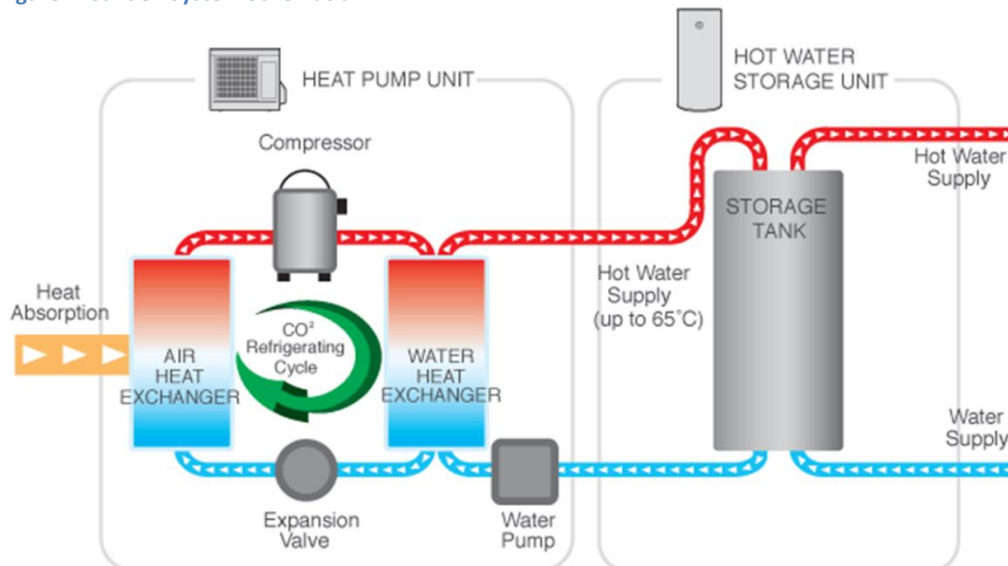

Research Overview

This research is conducted under and funded by BPA's Technology Innovation Program. Its project designation is TIP 292. The original project manager was Kacie Bedney Rossman, to whom this report is dedicated. She has been ably followed as Project Manager by Janice Peterson. Like Kacie, Janice participates actively in the project direction and details.

A key component of the project is its matching sponsors, which include Avista, Energy Trust of Oregon, the Northwest Energy Efficiency Alliance (NEEA), Ravalli Electric Cooperative, and Tacoma Power. These partners engaged with the project, found field study sites, and advised the project staff. All of them were actively involved in the project Advisory Task Force together with BPA, interested utilities, and individuals. This advisory group played an instrumental role in the project success by reviewing draft protocols and reports, reviewing and advising on project decisions, and forming a bridge between this emerging technology and utilities and other interested parties.

The research was divided into several sections by Stage Gates, which represent practical divisions of the research plan to allow meaningful decisions on proceeding with research investments. The Stage Gates established for this project were:

Stage Gate 1: Select equipment to be tested. At the time of the proposal, it was known only that the performance of a split system water heater would be tested.

Stage Gate 2: Review lab test results. The results from the lab tests determined if the research would move on to the field study.

Stage Gate 3: First Midterm field study research evaluation provided an opportunity to review the field study, monitoring, analysis method, and reporting.

Stage Gate 4: Second Midterm field study report allowed BPA and the Advisory Task Force the opportunity to examine field efficiency with a full year of data and to advise on the organization and content of the final report in the context of an interim report approaching finality.

Stage Gate 5: Presentation of results and assessment of the market potential for this technology.

In practice, the research was divided into two main parts: the lab test and report, and the field study with two interim reports. The field study findings are combined into this final report representing the completion of the research project.

Throughout this report, WSU attempts to provide not only the findings, but their implications. Lessons learned are included because they may provide insight to other researchers, or to installers or designers of this type of water heater and monitoring equipment. It has been a very rewarding journey into the unknown.

Project Organization

The WSU Energy Program served as project manager and guided all aspects of implementation throughout the project. A key part of the project's success was its Advisory Task Force, which held its organizing meeting on December 18, 2012 as the project was being launched. This group consists of BPA's Project Manager and subject matter experts, and lead staff from partnering organizations including Avista, Energy Trust of Oregon, NEEA, Ravalli Electric Cooperative, and Tacoma Power. The Heat Pump Store, Idaho Power, Puget Sound Energy, and Snohomish PUD were also part of the original Advisory Task Force.

The Advisory Task Force was active in choosing equipment to test, developing and reviewing field test protocols, and reviewing and commenting on draft reports. Partnering utilities also recruited field sites and provided support for the system installation, including working with building officials to secure permits.

Meetings of the Advisory Task Force were well attended, and took place via conference call and at regional events such as the Efficiency Exchange. The Task Force also attended a lab tour in 2013 and visited the field sites in 2014.

An important development was the Advisory Task Force vote to expand its coverage beyond TIP 292 and become the advisory group – with additional members – for TIP 302 (research on the demand response potential of CO₂ refrigerant HPWH), TIP 326 (research the use of the water heaters studied in TIP 292 for combined space and water heating in new homes), and now TIP 338 (research on combined space and water heating in existing homes for both efficiency and demand response performance). Additional members include PNNL, Benson County PUD, and Inland Power.

Also key to the project success were WSU contractors Ecotope and Mark Jerome, now with CLEAResult. Ecotope conducted the lab test in partnership with Cascade Engineering Services of Redmond, Washington, and analyzed and reported the data. Mark Jerome assisted with and guided system installations at the lab and field sites.

Monitoring equipment was installed by David Hales, WSU Energy Program. Mr. Hales also performed troubleshooting and initial commissioning of the monitoring systems.

Data analysis was conducted by Adria Banks of WSU. She was assisted by Ecotope in details of water heating analysis. Ben Larson, Nick Kvaltine, and Michael Logsdon also performed the multi-variant analysis and reviewed all technical reports for accuracy and clarity.

Lab Test

The lab test took place in April and May, 2013. The test was run on the GAUS-315EQTD manufactured by Sanden in Australia after an original attempt to test a more complex 104-gallon Sanden unit made in Japan capable of producing hot water ranging from 149°F to 194°F. The unit made in Japan arrived at Cascade Engineering Services (Cascade) in Redmond, Washington, the test lab, on January 17, 2013. It was to be tested in March, but when examined on February 15, 2013 at the lab it was found to have lost its refrigerant charge. The decision was made by Sanden to replace it with the Australian system because it had a smaller tank, was simpler to install and use, and more affordable, making it more appropriate for the U.S. market. This Australian unit is the subject of the lab test, the field tests, and subsequent research.

The purpose of testing was to subject the CO₂ water heater to the same protocols as other HPWHs. These included: U.S. Department of Energy (DOE) Standard Rating Point Tests at 67.5°F; Modified DOE Standard Rating Point Tests at 95°F, 50°F, 35°F, and 17°F for Northern Climate Specification (NCS) Energy Factor Rating; Draw Tests for NCS Delivery Rating; and COP Curve Performance Mapping at 50°F and 67°F. Compressor noise was also measured.

During the tests, the Advisory Task Force was invited to Cascade for a lab tour on May 10, 2013. Thirteen members representing ten organizations attended in addition to Ben Larson of Ecotope, and Kumar Banerjee of Cascade, who hosted the tour. A lively technical discussion took place in which Jack Callahan, BPA, proposed a solution to calculating efficiency with multiple sensors reading changing tank temperatures at different levels. Ben Larson presented the preliminary results of the testing, which revealed a level of performance previously not seen in HPWHs.

The final GAUS-315 test report was issued September 18, 2013 (Larsen, 2013). It states, in the abstract, “Overall, the results suggest the HPWH is an extremely efficient heat pump water heater and suitable for all domestic water heating applications in the Pacific Northwest.” [Emphasis added.]

The main results are summarized in this table (**Table 1**) from the study report (Ibid, p. 11). The efficiency curve developed in the lab is also used in the analysis section of this report.

Table 1. Summary of Results

Metric	Measured Value
First Hour Rating (gal)	97.8
Energy Factor (std. conditions)	3.35
Energy Factor @ 50°F ambient	3.11
Northern Climate Energy Factor	3.2
Tank Heat Loss Rate (Btu/hr °F)	4.0

Field Study

Proof of concept and rapid development of marketable technologies depend on subjecting them to real-life conditions. While lab tests can define the product potential measured by protocols, field tests are necessary to measure performance under circumstances and identify issues that can only be created or revealed by installers, users, pets, weather, and other occurrences, whether foreseen or unforeseeable.

The original scope of work submitted with the proposal that created this study stated, “The methods to be used in this project include working with parties whose actions may be unpredictable regardless of the best efforts of WSU Energy Program. This includes building officials and homeowners... the deliverable dates in the task statement are reasonably expected if deliveries and permissions are made and bestowed within reasonable time frames, and are not totally firm dates.” This language turned out to be prophetic.

The field study has accelerated the development of a CO₂ refrigerant HPWH for the U.S. market by identifying issues raised by building officials, researchers, installers, plumbers, electricians, and homeowners. All have fed directly into equipment redesign to cope with freezing climates in the U.S., standard U.S. fittings for plumbing and electrical connections, specific instructions on heat tape design and installation to avoid significant energy waste, the proper type of UL listings to obtain, the need for an alarm if a line becomes clogged, the need for certification of the refrigerant by the U.S. Environmental Protection Agency, and the need to keep the technology cost-effective – to name some of the useful knowledge gained.

Description

Four split system CO₂ refrigerant HPWHs were installed in homes across the region beginning in fall 2013. These homes are located in Tacoma, WA; Corvallis, MT; Addy, WA; and Portland, OR. The field study was designed to test the performance of the technology in all three of the Pacific Northwest’s heating climate zones. The four host organizations were Avista, Energy Trust of Oregon, Ravalli Electric Co-op, and Tacoma Public Utilities. Each of these partners actively recruited host sites for the field tests.

Each test site met certain criteria of occupancy and history of energy use. Each site had a minimum family size of four, the water heater replaced by the test unit was electric resistance (ER), and the same family members used the ER water heater for at least three years of occupancy.

Site Summaries

The specific sites were typical of the regional heating zones they represent, as shown in **Table 2**. The site near Corvallis, MT, is at 4,250 feet, about 1,000 feet higher than the City of Corvallis, giving it heating degree days (HDD) typical of heating Zone 3. The site in Addy, WA, has a climate similar to Spokane. The Zone 1 sites are warmer than the median value but represent the most populated areas in the region.

Because the systems do not have ER auxiliary heating elements, the HPWHs at the coldest sites were installed in parallel with emergency ER heaters. The systems in Portland and Tacoma did not have any backup water heating. The backup water heaters at the colder climate test sites were not used during the period reported. Site characteristics are shown in **Table 3**.

Table 2. Heating Zones of Four Test Sites

	Median HDD ₆₅ ²	Site Location	Site HDD ₆₅
Heating Zone 1	5,182	Portland, OR	4,461
Heating Zone 1	5,182	Tacoma, WA	4,696
Heating Zone 2	6,824	Addy, WA	6,842
Heating Zone 3	8,363	Above Corvallis, MT	8,156

Table 3. Test Site Characteristics

	Addy	Montana	Portland	Tacoma
Adults	2	2	2	2
Children ≤12	1	0	2	2
Teen	2	2	0	0
Years of Occupancy	16	10	5.4	16.5
Age of House	1998	2004	1926	1978
Conditioned Floor Area	3,000	4,300	1,950	1,719
Number of Stories	1 + Bsmt	2 + Bsmt	2 + Bsmt	2
Number Bedrooms	5	5	3	3
Number Full Baths	3	3	2	1
Number Half Baths	0	1	1	1
Original Tank Size	50 gal.	80 gal.	50 gal.	50 gal.

Field Study Design

The field study was designed to monitor the systems for at least 12 full months. This report is cumulative with the first and second midterm reports and covers all of the monitoring – from installation through final data collection in 2015. The installations were completed as early as October 30, 2013 and the final installation was completed and producing data on February 8, 2014.

Regional monitoring protocols³ were followed – except those related to impact on conditioned space – because the split system has no impact except tank loss which was measured in the lab as a rate less than one watt. Data points include:

- Water flow, time and volume through hot water tank measured at the cold water inlet
- Temperatures
 - Cold water supply
 - Hot water to tempering valve
 - Tempered water to house
 - OSA temperature
 - Inside air temperature near the hot water tank
- Power measurements
 - Time and amperage of compressor electricity use
 - Time and amperage of outdoor pipe freeze protection (heat tape) electricity use
 - Time and amperage of backup domestic hot water systems (for two sites)

² Source: Northwest Power and Conservation Council, 6th Power Plan Assumptions

³ See the monitoring protocols in Ecotope and NEEA, 2015, *Heat Pump Water Heater Model Validation Study*, NEEA Report #E15-306, March 2015, p. 15 and Appendix A.

The tested system has no heat source other than the heat pump. At the two cold weather sites where ER water heaters were retained as backup, these water heaters are monitored but they were turned off at the breakers and empty of water unless needed. During the period covered in this report, they were not used as back-up. The ER unit in Montana was used for baseline testing only.

The monitored data are used to characterize each installation site, and to calculate energy used per unit of hot water and field energy factors (FEFs) for each of the units operating under typical household use conditions. The setup of the field monitoring is shown in **Figure 5**.

Figure 5. Field Monitoring Setup

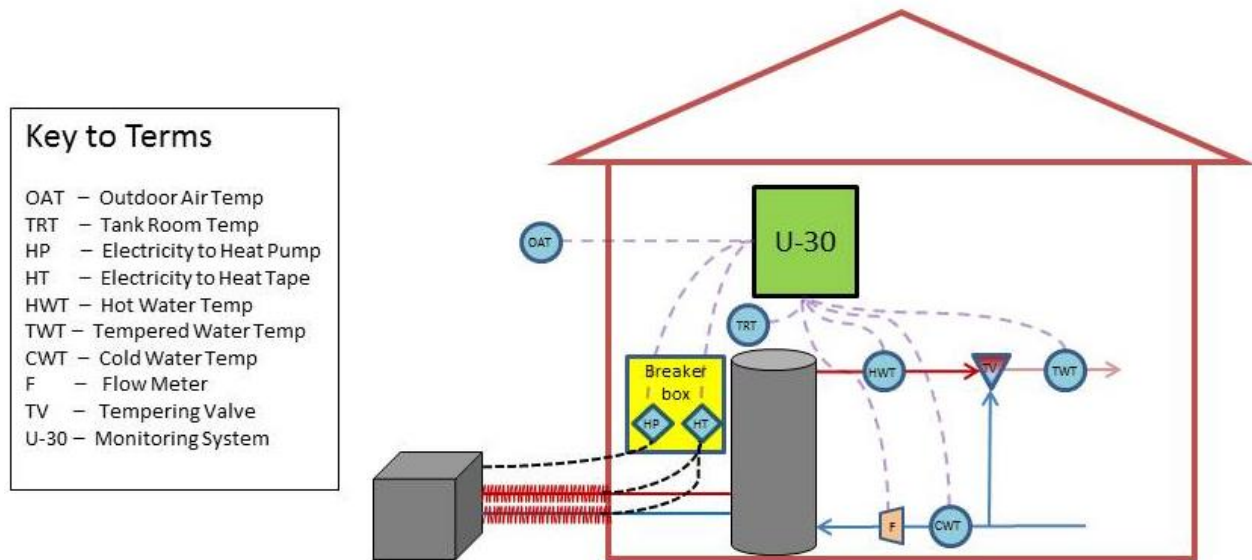

The monitoring collection device is an Onset U30 GSM with cellphone contract so data can be downloaded daily and settings on the logger can be controlled remotely. This quality assurance ensures that issues are identified and corrected as soon as possible. The following monitoring equipment was used:

- U30 GSM (includes 10-port option and data plan)
- WattNode (WNB-3Y-208-P option 3)
- 50 amp split core alternating current (AC) transformers
- Pulse adapters S-UCC_M006
- 12-bit temperature sensors with 6-meter cable
- 12-bit temperature sensors with 17-meter cable
- Water flow meter sensor (T-Minol-130)
- Pulse adapter for flow meter S-UCD-M006
- 10K ohm type 2 thermistors with temperature documentation
- Thermal wells for the thermistors

Description of Analysis

The period covered by this analysis is from the time monitoring began through the end of monitoring at the various sites in 2015. Monitoring at Addy ended when the house was sold in April 2015. The Montana and Tacoma sites were decommissioned in midsummer 2015, and the Portland site was monitored until mid-December 2015. Because system installation spanned over three months and monitoring ended at different times, there are different-sized data sets for each system.

The analysis in this report examines the efficiency of the system and a number of its operating parameters, including the temperature of the cold water supply, heated water, and tempered water. The volume of water used for tempering the temperature of the hot water before use was calculated. Tempering was required due to the high (approaching 150°F) temperature of the heated water. The total volume of water used and daily use averages are also calculated.

This analysis also delves deeply into issues with systems and monitoring that directly impacted performance and the analysis of performance. These include the impact of freeze tape and energy use after problems were resolved; the distortion caused by sunlight striking the OSA temperature sensor and how moving the sensor into the shade improved the data; and the impact of blockage on system performance at the Portland site and how the system performed after the owner, with assistance from the manufacturer, fixed the problem.

Comparing Heat Pump Water Heaters – Energy Use per Unit of Hot Water

The Pacific Northwest is the national center for HPWH testing, deployment, and problem solving. The Northern Climate Specification is a case in point. Another is the field research funded by BPA and NEEA. Several field studies on HPWH performance report their performance in a number of ways; this study does that as well. One of the most compelling ways of viewing the data is energy use normalized by flow created by Ecotope and stated in its *Heat Pump Water Heater Model Validation Study* (Ecotope and NEEA, 2015, pp. vii, 41, and 74). This report examines energy use per gallon, which brings it into conversation with other HPWH research and regional studies.

Energy Factor vs. Coefficient of Performance

The lab test report (Larson, 2013) refers to both coefficient of performance (COP) and energy factor (EF).⁴

- COP is the ratio of the energy produced by the water heater to the energy used to operate the heat pump. In the lab, the researchers have temperature sensors in the tank so they can calculate the energy in the water.
- The EF is specified by a DOE 24-hour lab test with a certain hot water draw pattern and monitoring period to observe tank heat losses (DOE, 1998).

⁴ *Laboratory Assessment of Sanden GAU Heat Pump Water Heater* by Ben Larson, Ecotope, 2013.

- In this report, the efficiency is labeled an FEF because it consists of observations at a range of outdoor air temperatures (OATs) and draw schedules. Further, it includes tank and plumbing losses as they occurred in field conditions. The title “Field Energy Factor” builds on the DOE term “Energy Factor” as a performance indicator in actual use. The FEF more closely approximates home use than a COP because it incorporates loss from cooling pipes between draws, cold water supply in winter, and other factors that impact energy use in the field.

Challenges in Monitoring

Logger instrumentation required some adjustment in the first five months of data collection. The Tacoma and Montana sites were initially programmed to record measured variables every five minutes. After consultation with data analysts, these instruments were adjusted to record data at one-minute intervals in mid-December 2013. The Addy and Portland sites were initiated in late January and early February 2014, respectively, and instrumentation was set to log every minute upon installation.

Location of outdoor air sensors is critical. They must be located where no distortions in temperature will impact the recorded data. The most common problem is solar radiation, and this issue occurred at two sites requiring substitute OATs to be used in analysis until the sensors were moved.

Baseline tests were added to the Montana site. It took some time to arrange for the busy plumber to re-route the plumbing to allow water in both the electric resistance water heater (ERWH) and HPWH to flow through the temperature and flow sensors by simply turning two handles. The bigger problem occurred during the cold weather test when the outside unit was not drained when it was turned off. It took a hair dryer to thaw out the pump and heat exchanger, but the unit was not damaged by freezing solid in this case. The results are discussed in the section Montana Baseline Testing, page 26.

Flow meters must be calibrated to ensure accuracy in analysis. This was highlighted by the baseline test analysis which originally showed efficiency greater than one for the electric resistance water heater. This is discussed further in the section Montana Baseline Testing (page 26).

Further challenges were caused by events outside the control of the researchers, but they impacted the monitoring:

- Improper installation of heat tape on the pipe between the tank and outdoor unit. The increased energy use distorted the analysis of normal system performance (page 15).
- Pet-induced equipment malfunction. An incident of this type is discussed along with the graph showing its impact (page 19).
- A blockage in the pipe between the tank and the outdoor unit at one site negatively impacted performance until it was discovered after it eventually caused the system to shut down (page 19).

These challenges are discussed because they are performance issues that manufacturers and users should be aware of so they can be avoided or repaired.

Analysis Protocols

Data files from the four sites were compiled for analysis. Depending on the site, data from the first day or more was dropped to eliminate readings affected by set-up and testing of instrumentation. All remaining data, regardless of logging frequency, were used in the analyses.

As described in the Field Study Description, the following values were calculated:

- Average temperatures, by flow event or by day, for cold water supply, hot water, and tempered water.
- Thermal energy required to heat cold water supply for each flow event.
- Volume of water added to temper hot water for each flow event.
- Volume of total water for each flow event.

To calculate representative temperatures for cold water supply, hot water, and tempered water, at least three consecutive flow measurements were required; where one-minute data was taken, this resulted in a minimum total flow of three minutes.⁵ Mean temperatures were then calculated by dropping the initial temperature reading and averaging over the remaining readings for a given flow event or draw. These values were also used to approximate daily average temperatures for cold water, hot water, and tempered water. Daily averages were used as the representative mean water temperatures for short-duration draws that were less than three consecutive minutes. Where no draw within a given day met these criteria, daily averages were not calculated. When only intermittent short draws (less than three minutes) occurred during a given day, the mean of daily average water temperatures from surrounding days was used.

Because only water volume flowing into the HPWH was metered via data loggers, additional water added to temper the hot water flowing to the home was calculated for each flow event by using the known water flow (gallons) and the difference between the daily average tempered water to the house and the average cold or hot water temperatures, respectively. Total water flow for each flow event was then the sum of the cold water flow and the added water. Average water temperatures were used to calculate the thermal energy needed to heat the cold water for each draw. The energy needed to heat the cold water supply for each flow event was calculated as:

$$\text{Hot water}_{\text{Btu}} = \text{Volume}_{\text{(cold water)}} \times 8.34 \times (\text{Avg. hot water temp.} - \text{Avg. cold water temp.}) \\ \times 1 \text{ Btu/lb/}^\circ\text{F, where 8.34 lb/gal is the density of water}$$

Metered and computed values were summarized both daily and weekly. For presentation in this report, FEF values were calculated using weekly averages as:

$$\text{FEF} = \text{Hot water}_{\text{Btu}} (\text{energy contained in total hot water delivered}) / \text{Total Energy In}^6$$

Data summaries and calculations for 14 to 23 months of data collection at each site (depending on installation and end date) are presented in this final report.

⁵ Most data taken was one-minute data. For a discussion of one- and five-minute data, see page 12.

⁶ Total Energy In includes that used to operate compressor, fan, and water pump whether used for water heating, defrost, or water circulation freeze protection. ER heat tape energy would normally be part of Total Energy In if installed and operating properly. If not, the distortion caused by including it outweighs insight into operation of the HPWH.

Issues Addressed and Lessons Learned

OSA Temperature

Figure 6 shows the daily average OSA temperature from the beginning through the end of monitoring. Each day has a bar – the dark center is a dot that shows the average temperature for that day, and the bar extends to the daily extreme temperatures. The Montana site had average daily temperatures below 0°F in December 2013 and February 2014. Cold spells occurred at the other sites during these times. Periods highlighted in green represent baseline testing periods at the Montana site.

Figure 6. Daily Average Temperature at Each Site through July 2015

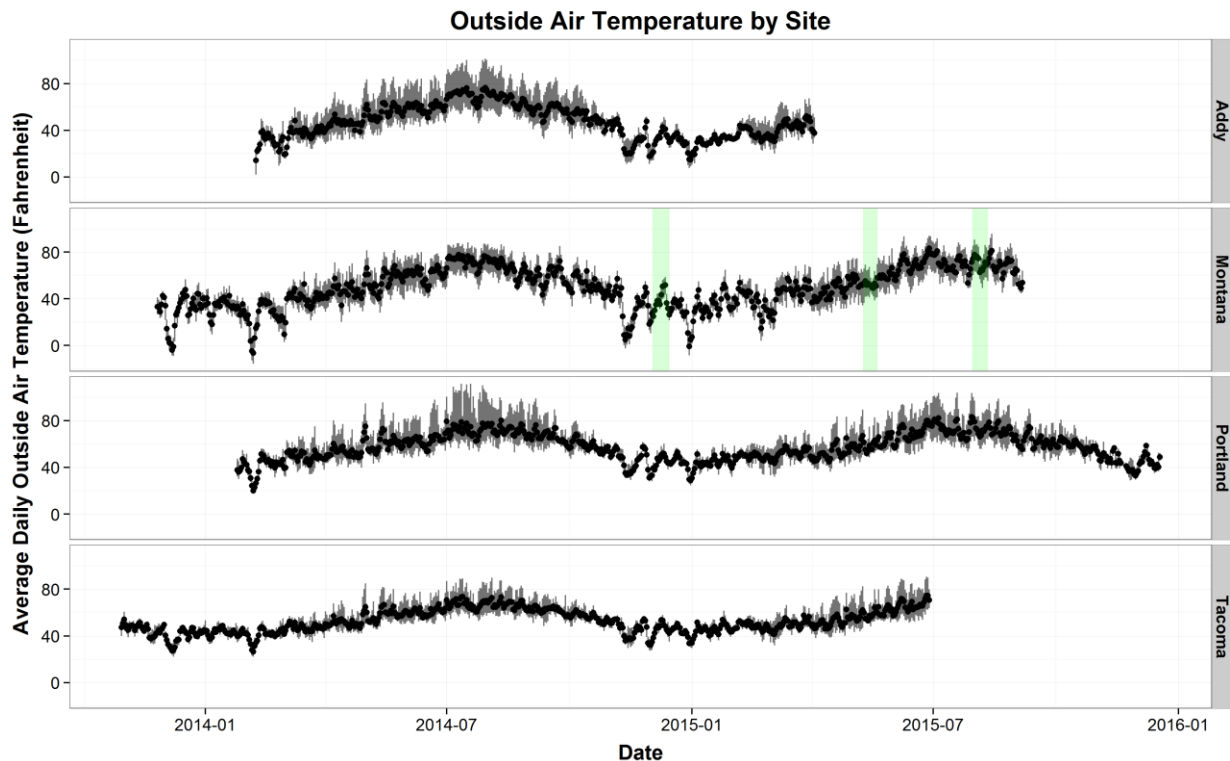

As temperatures climbed during the spring and summer of 2014, substantial high temperature variability was observed at the Addy and Portland sites. This created a razor back effect visible in **Figure 6**, caused by placement of OSA temperature sensors at locations where they were warmed directly by the sun. The analysis of water heater performance in relation to outside air temperature (OAT) would be distorted by this misrepresentation of a key variable. To avoid this, weather data from the National Weather Service is used for the OSA temperature at the Addy and Portland sites from installation through early October. In fall 2014, the OSA sensors were moved or shaded at these sites to reduce future impact of solar warming, so site data is used after correcting sensor placement.

Table 4 shows the low, average, and standard deviation from average OATs at each site, and the number of days sampled. Other factors, including freeze protection, cold water supply temperature, the temperature in the tank location, and water usage patterns, are discussed below.

Table 4. Low, Average, and Standard Deviation from Average OAT at Each Site

Site	Minimum OAT (°F)	Mean OAT (°F)	Standard Dev. OAT (°F)	Sampled Days (n)
Addy	2.08	46.6	± 16	420
Montana	-15.68	49.6	± 18.1	604
Portland	17.89	57.1	± 13.4	690
Tacoma	22.2	52.9	± 10.6	607

* Daily proxy temperatures are used for Portland and Addy temperature summaries for periods with sensor issues.

Freeze Protection

The split system is vulnerable to cold weather issues. Like any heat pump that operates outdoors, it is subject to frost. In addition, because it is a hydronic heater, the water lines coming to and from the indoor tank are subject to freezing. The system is equipped with a defrost cycle to protect the outdoor coil and it circulates heated water to protect the pipes and gas-to-water heat exchanger in the outdoor unit. The energy needed to perform these functions is included in the heat pump energy use in all of the analyses.

In addition to the on-board freeze protections, the manufacturer advises that heat tape be installed to protect the outside lines between the tank and the outdoor unit. The manufacturer did not provide heat tape and assumed that the proper type would be chosen and properly installed. Unfortunately, the heat tape was installed improperly at two sites, causing the heat tape to use energy constantly. Specifically, the pipe runs were short and the installer used only one controller and looped it to cover both lines. This invalidated the heat tape control system which relies on contact with the pipe. The problem was discovered when analyzing the energy use for the heat tape during the winter of 2013-14. The problem was partially addressed by installation of thermostats prior to the winter of 2014-15.

The impact of the improper installation initially resulted in increased electrical use of 3-7% of HPWH energy. After the malfunction was discovered, the heat tape at Addy and Portland was unplugged during the warmer spring and summer months. As colder weather approached in the fall of 2014, these sites were equipped with thermostats. However, thermostats alone were insufficient to completely resolve the improper installation and these sites continued to experience an energy penalty of 1-2% of HPWH energy. At sites with properly installed and functioning heat tape, the impact of heat tape was 0.1-0.3% of HPWH energy use.

Figure 7 shows the heat tape energy use. Note the changed energy profiles at Addy and Portland after they were plugged back in during fall 2014. It is clear that the thermostat installation did not completely fix the problem at these two sites. If installed properly, heat tape can be a cost-effective secondary protection when the power is on, as shown by the results in Montana and Tacoma. However, if heat tape is installed improperly, it results in a substantial energy penalty.

Figure 7. Heat Tape Energy Use

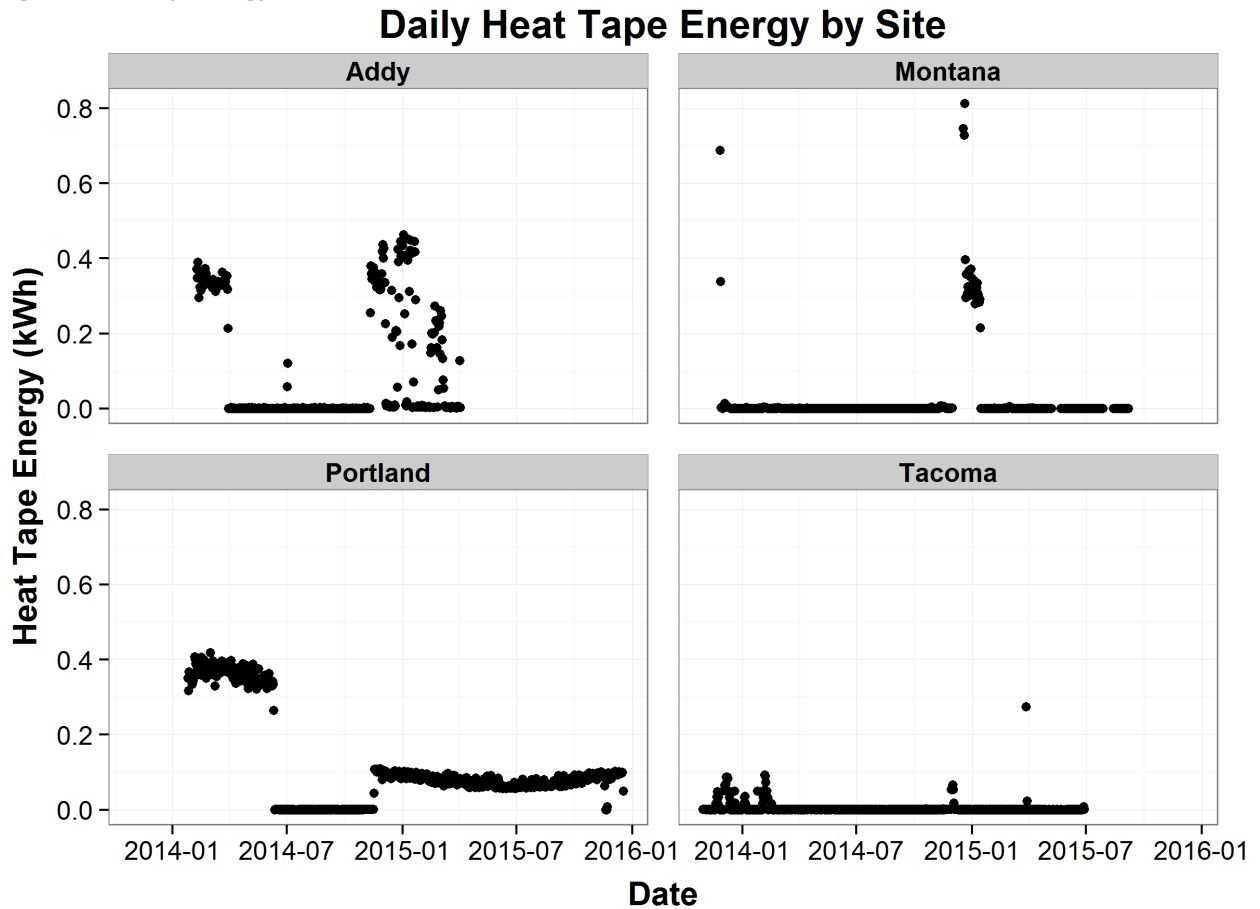

A problem not addressed by either the onboard freeze protection or heat tape is what happens when power is off during a cold period of substantial duration. This question was posed to the manufacturer and discussions led to a proposed automatic drain and refill function that may be available to purchasers of the new system to be marketed in North America. This system would be activated by an onboard system that senses when the temperature has been at or below freezing for a substantial period of time with the power off.

The risk of an installer improperly installing heat tape and causing a significant energy penalty should be addressed in the installation manual and training. The purpose of this report is to identify the performance of the system if installed properly with all of the issues that necessarily impact normal operation. An ancillary purpose of this research is to identify issues that should be addressed, such as the danger of freezing during long power outages and improper installation of heat tape.

Temperatures

The graphs below show temperatures at the four sites that may impact performance. They are shown as plots of dots showing the daily average measured temperature of tank rooms, cold water supply, hot water output, and tempered water.

Tank Room Summaries (from Metered Readings)

The space surrounding the tank impacts the heat loss rate from the tank and piping. All of the sites show some seasonal variability in tank room temperature, with the most significant seasonal changes in Portland and Tacoma. Addy is most consistent and overall warmest because the tank was located near a space heater. Montana appears to have the coldest tank environment. The daily average temperatures are shown in **Figure 8**.

Figure 8. Temperature of Space Surrounding the Tank

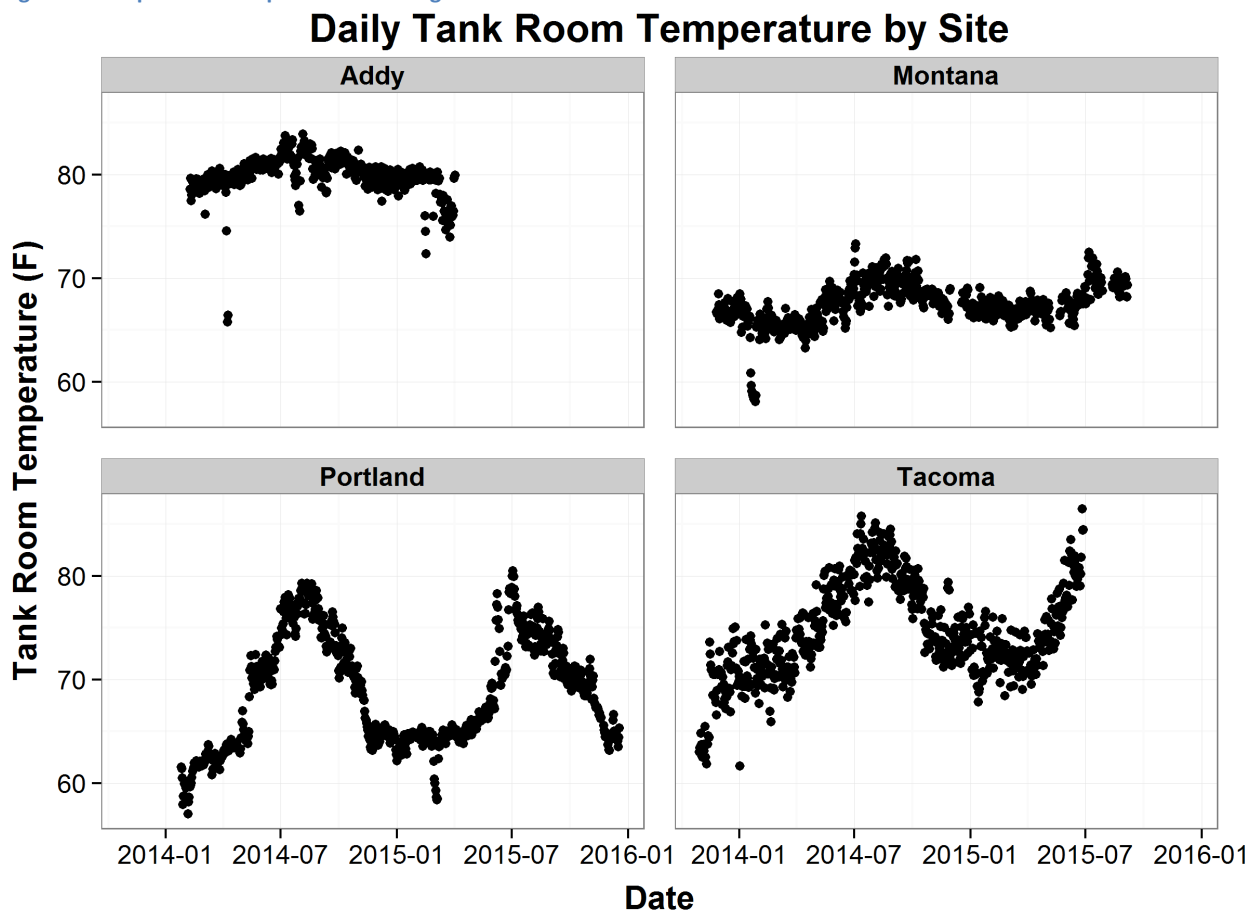

Household Water Temperatures (from Flow Event Averages)

Figure 9 shows the average cold water supply temperatures at each site. The temperature of the incoming water impacts the system efficiency because it determines the amount of heat that can be transferred in the gas cooler. Colder water increases the delta T, allowing more heat to be transferred from the super critical CO₂. The temperatures at the four sites were all within the acceptable operation temperature.

As found with the tank room temperatures, the median cold water supply temperatures increased at all sites during warmer weather, though the range of variation was less at the colder sites where the water supply pipes are deeply buried (four feet in Montana). The asymmetric increase and decrease at the Portland and Tacoma sites is interesting, leading to the observation that the rise in temperature during the spring is slower than the decline in fall.

Figure 9. Average Cold Water Supply Temperatures at Each Site

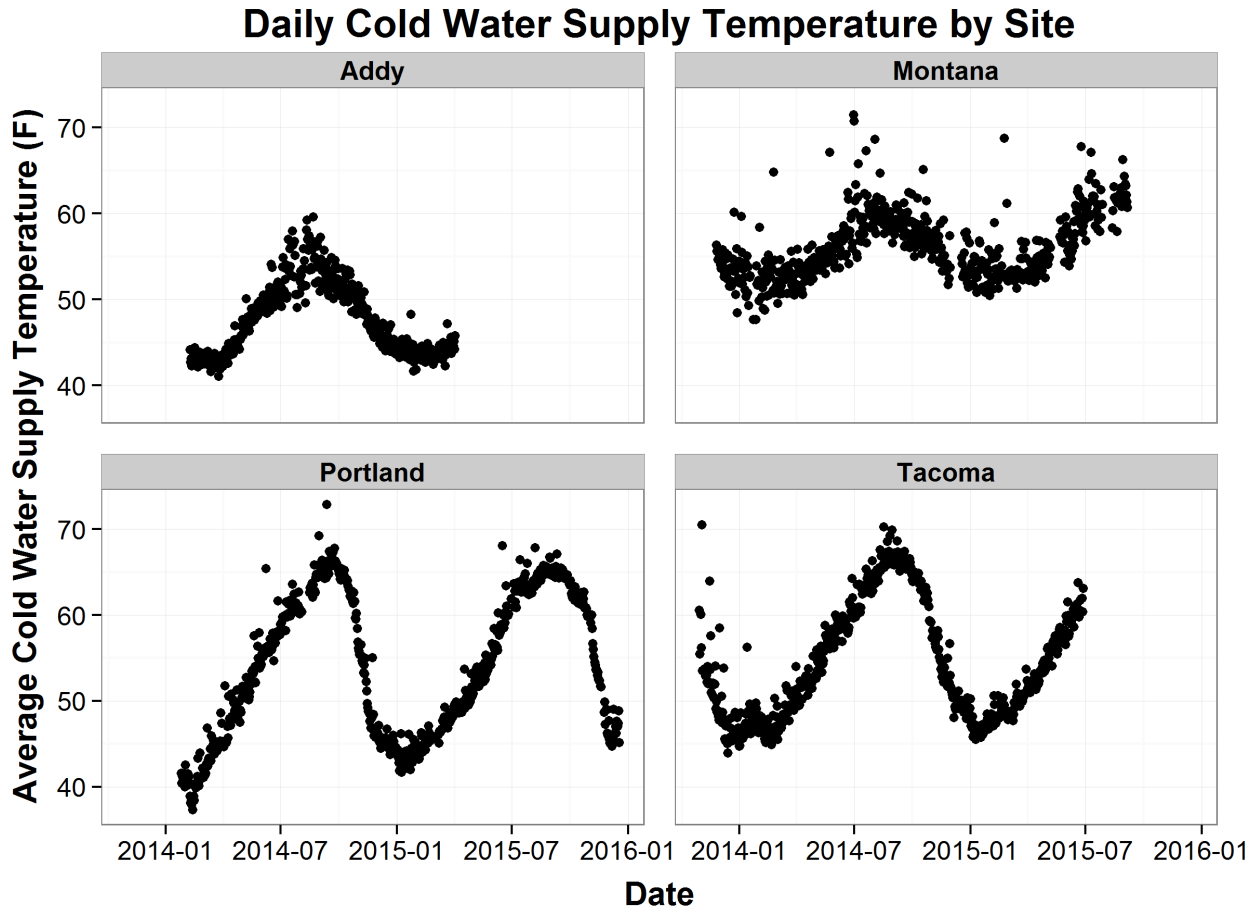

The reading of inlet water temperature is impacted by the sensor heating up due to its location in a pipe connected to a tank of very hot water. That pipe is heated by conduction from the water heater, and this masks the true temperature of the incoming water. This effect is reduced by requiring a minimum of three consecutive readings for calculating average temperatures. However, outliers caused by tank heating are still apparent in the temperatures used in the calculations, although the errors are lower than those that result from using instantaneous temperatures.

As **Figure 10** shows, the average hot water output temperature is very close to 149°F at all four sites, indicating proper function of the heat pump. This figure demonstrates the consistency of the technology regardless of changes in the OAT, tank room, or supply water. According to the manufacturer, CO₂ refrigerant heat pumps operate best when producing high-temperature hot water.

Figure 10. Average Hot Water Output Temperature by Site

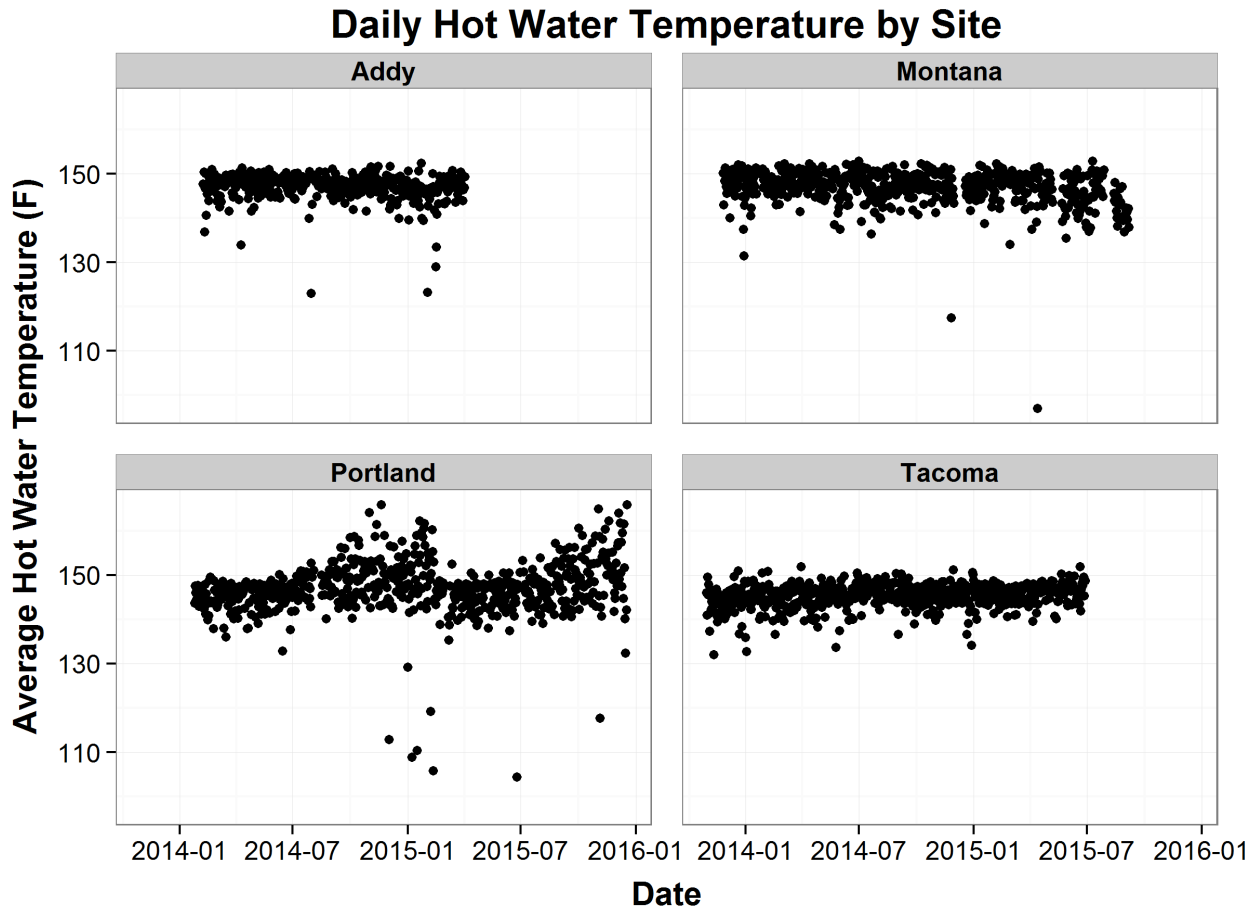

The water temperature outliers falling below 100°F at the Tacoma site all occurred on January 2, 2014. The owners' dog, terrified by New Year's Eve fireworks, hid under the deck where the pipes and wires run to the outside unit. The dog became tangled in the tank temperature sensor wire and pulled it loose. The problem was discovered the next day when the family ran out of hot water, because without the sensor signal, the system did not operate. The homeowner reconnected the wire and the system function was restored.

The Portland site shows the highest hot water temperatures – approaching 170°F at two times during the monitoring. In early December 2014, the system at the Portland site shut down and had to be reset to operate. The frequency of the shutdowns (visible in the low outliers between December 2014 and February 2015) increased until the system would not reset. The manufacturer's representative provided phone assistance to the homeowner, who removed the cover from the outdoor unit and opened a filter on the cold water line (shown in **Figure 19**). It was clogged with debris, which slowed the water flow to a trickle and caused the unit to overheat. The homeowner cleaned the filter and reassembled the unit, and the problem was resolved. The issue reduced the efficiency of the system at the Portland site during the blockage.

WSU continued monitoring at the Portland site as long as possible to document the actual performance of the system when it was allowed to operate as designed. However, the output temperature again increased during the last quarter of 2015, indicating a recurrence of the problem. Upon checking, the filter was found to again be clogged by debris.

The source of the debris could be from periodic surges that the Portland water utility sends through the system, which commonly push debris that plugs aerators on sinks. The findings are discussed in the section, Portland Line Clog and Impact on System Efficiency (page 28).

Tempered Water Temperature and Use

Hot water use is measured in time and volume at the cold water supply to the water heater. Because the water coming from the HPWH is 150°F on average, the water must be tempered with cold water to a safe use temperature.

Each household in the study was equipped with a tempering valve to reduce the hot water supply temperature to a safer use temperature by mixing it with cold water. The mixed temperature was set by the homeowner. As shown in **Figure 11**, the average delivered temperature selected by the homeowners ranged between 120°F and 130°F. Temperatures varied slightly during the study. The Tacoma setpoint increased several degrees in January 2015, and the Portland setpoint appears to have incrementally increased from 120°F to 125°F over the course of the study period.

Figure 11. Average Delivered Water Temperature Selected by Homeowners

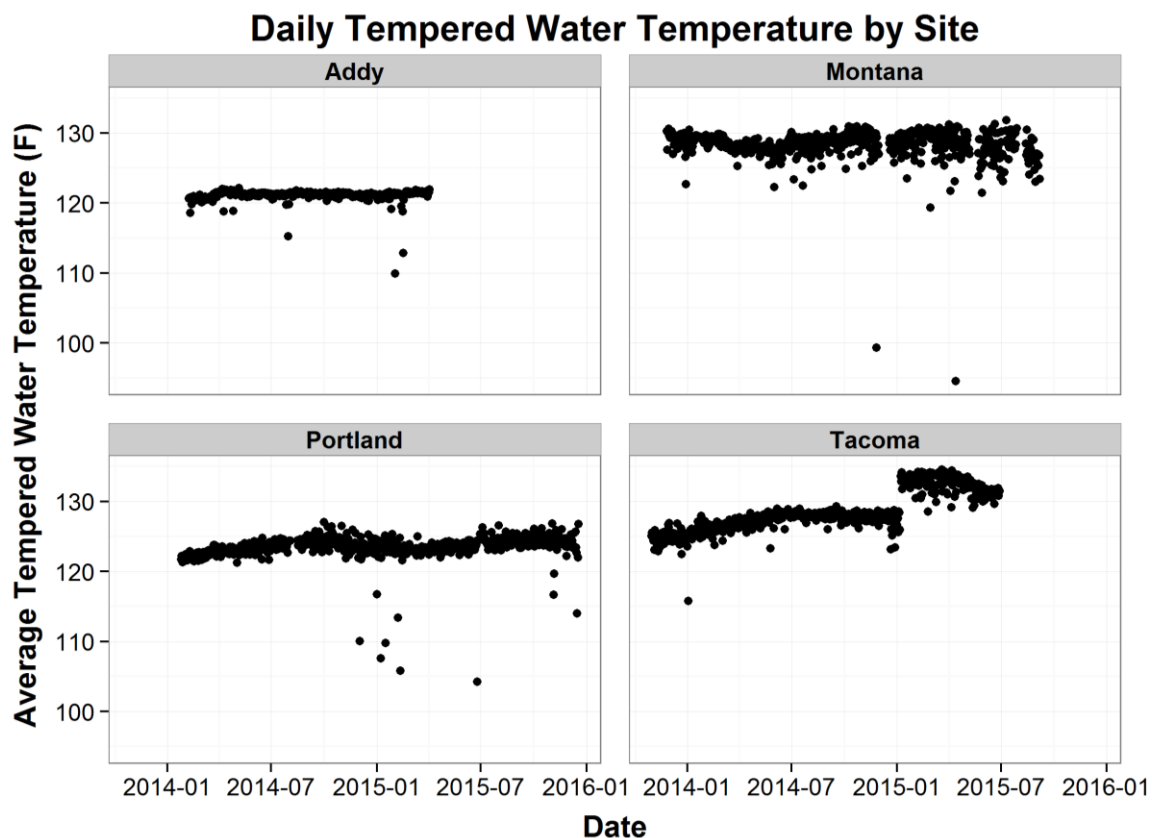

On a standard water heater, the tempered hot water temperature is set at the heater itself. With this technology, the output temperature is fixed and the tempered water set point is adjusted by the homeowner. The amount of cold water added to the hot to produce tempered water is calculated using the amount of hot water plus the temperatures of the hot water, the cold water, and the water flowing out of the tempering valve, if known. In this case, all three temperatures are directly monitored.

These calculations are done for each hot water flow event. **Figure 12** shows the total daily hot water use for each site, which varies over time. WSU has evidence that two major factors are driving the measured use: change in hot water use by the home occupants, and possible change in calibration of the flow meter. WSU performed calibration tests on the flow meters at three of the four sites. This is discussed further in the section Montana Baseline Testing (page 26).

Each site had at least four persons throughout almost all of the monitoring period (Addy had seven). Thus they exceeded the regional daily average of 45 gallons per household with fewer than three people, on average, at all sites but Portland, which used very little hot water. The site with the most variance in hot water use was Montana. The homeowner notes that beginning in July and August 2014, their athletic teenage daughter took a lot of showers and laundered athletic clothes after frequent workouts. In mid-June 2015, the household went from four to three persons and water use declined.

Figure 12. Daily Average Hot Water Use

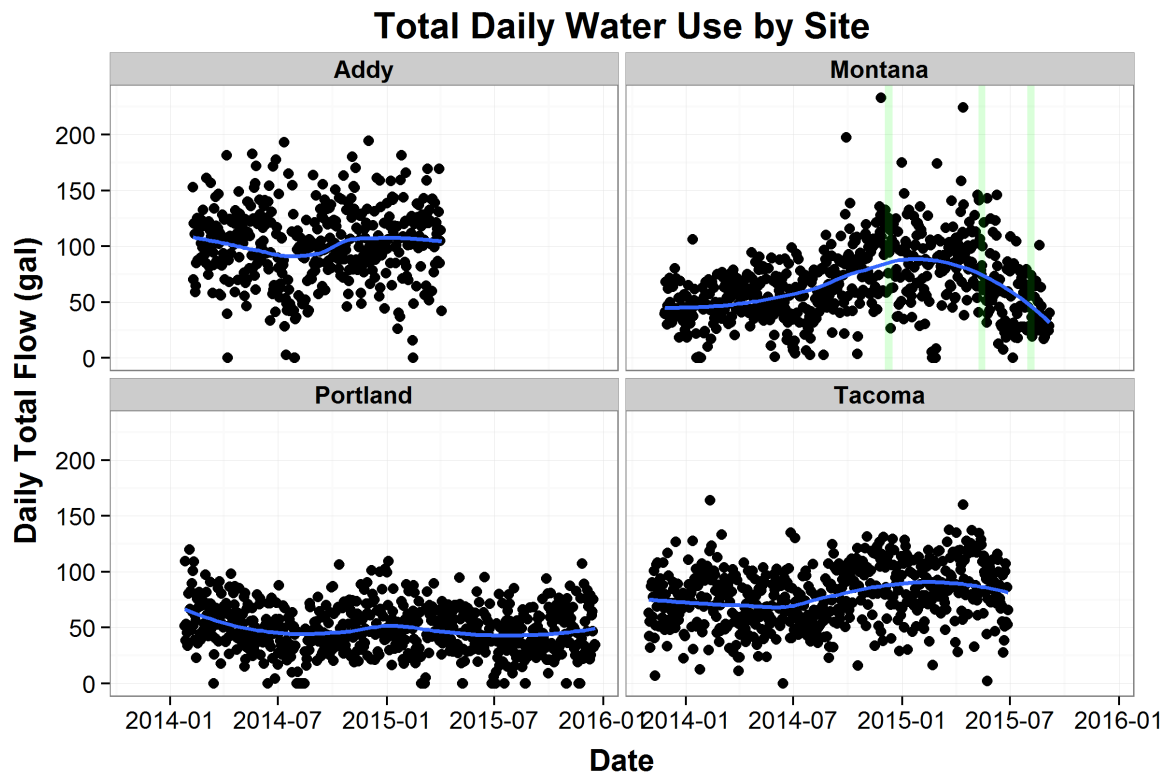

Electricity used by the heat pump increases as the OAT decreases. Seasonality of energy use at the sites is evident in **Figure 13**, which plots the daily kWh. Daily hot water use is relatively flat compared to energy use because the heat pump has to work harder in cold weather to extract heat. In addition, hot water use increases at least slightly during colder weather, which also increases heat pump load because

tempering water is colder and more hot water is needed to produce the water temperature set on the tempering valve (Ecotope and NEEA, 2015, pp. 36-38). The average daily electricity usage (excluding Portland’s clogging issue) ranged from 3.5 to 7.9 kWh per day. The relationship of these factors is discussed in upcoming sections.

Figure 13. Seasonality of Energy Use at Each Site

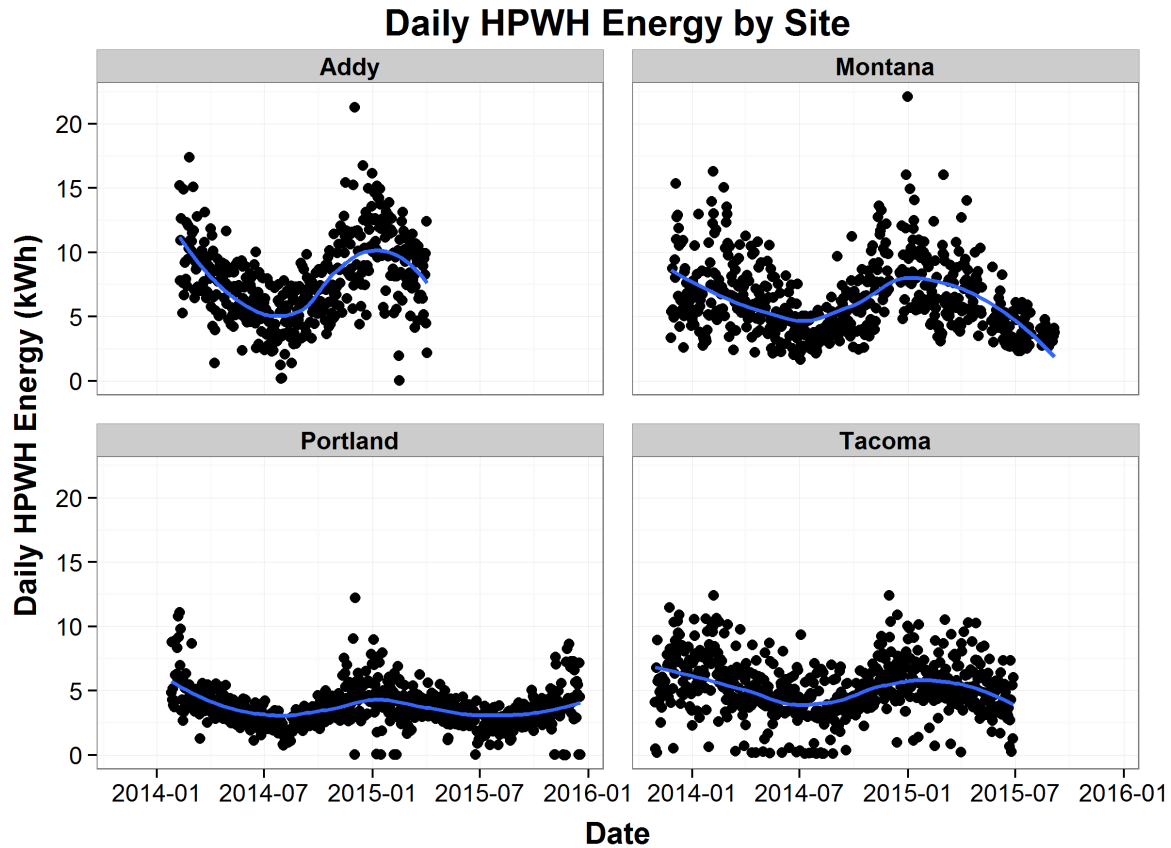

Billing Analysis

Each site provided at least three years of billing history plus all of the electricity bills for the monitoring period (through May or June 2015). This billing data was normalized against nearby weather stations for each site using *rterm*.⁷ Figure 14 shows the model residuals after accounting for weather over the billing period. Red lines delineate approximately when the HPWH was installed at each site.

There is wide variation in energy use even after the factor of weather is removed through normalization. Homeowners were surveyed about changes in energy use or occupancy over time, and several mentioned changes in occupancy or possible behavior that would contribute to confounding patterns. However, no clear responses that explained the full extent of the observed patterns were received.

With current methods, it is not possible to identify the impact of the HPWH installation on overall energy use given the magnitude of energy use variation.

⁷ Logsdon, Michael, 2015. *Temperature-Energy Regression Models for Building Energy Use (rterm) vsn 0.0.0.9000*. GitHub repository, <https://github.com/EcotopeResearch/rterm>.

Figure 14. Model Residuals after Accounting for Weather over Billing Period

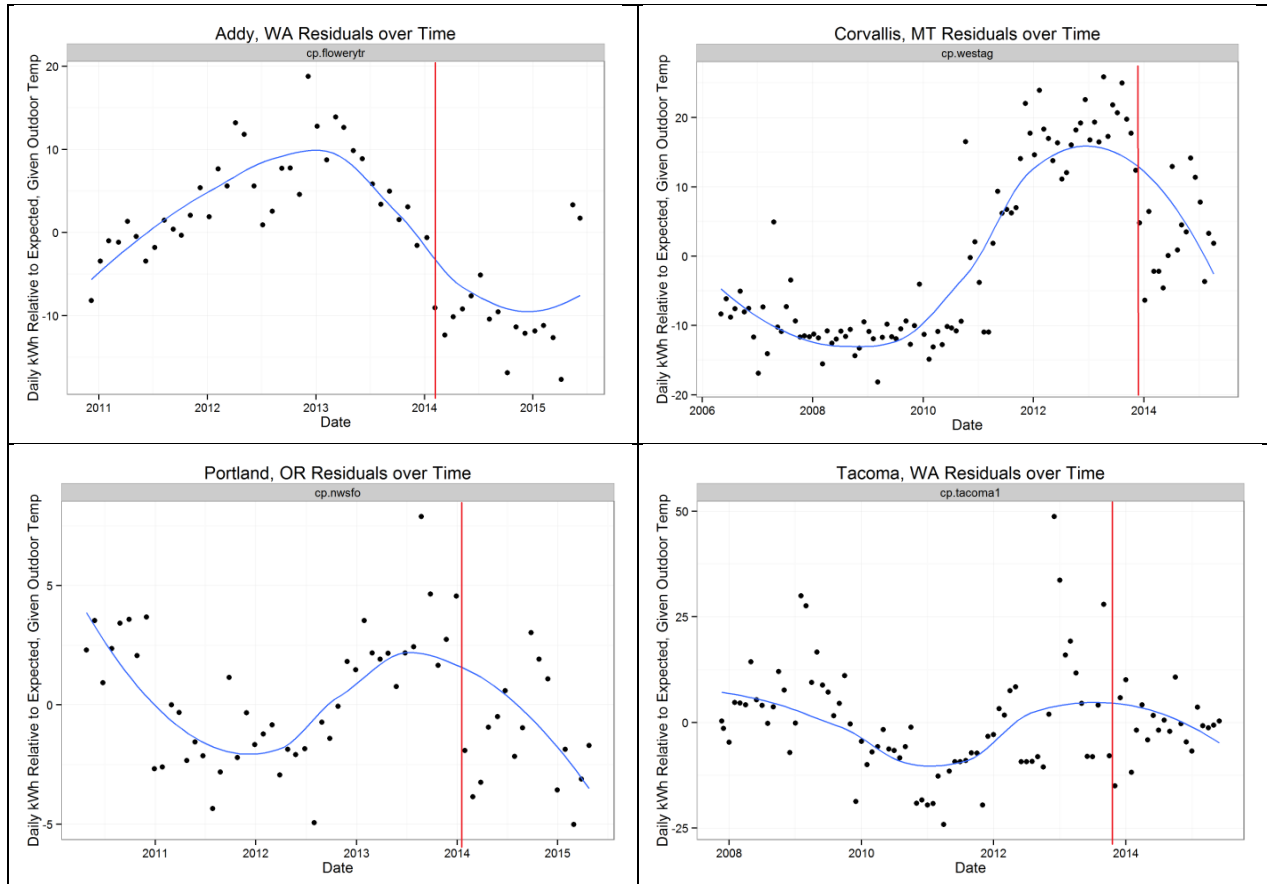

Survey Results

The occupants at each site were surveyed at the beginning of the study to characterize their water use and at the end of the study to assess their response to the system and its performance.

Table 5 shows the results of the survey. The characterization survey is indicative of water usage, and the survey results appear to corroborate the measured water use.

Table 5. Survey Results

Heat Pump Surveys				
	Montana	Addy	Portland	Tacoma
Showers/week	22	10	10	26
Shower time (min)	15	6	7	5 to 7
Baths/week	4/yr	1	4	3 to 4
Laundry loads/week	8	daily	2 to 3	2 to 3
Clothes washer type	front	ENERGY STAR	front	front
Clothes washer setting	warm/cold	warm/cold	NA	cold/cold, warm/cold
Dishwasher loads/week	2.5	8	4	NA
Post water use	same	more	same	same

System Performance

System performance integrates daily water flow with the heating energy used. **Figure 15** demonstrates a measure of efficiency in the daily amount of energy used per gallon. Different amounts of energy are used on some days even though flow rates and the OAT are the same. Daily energy and water use in large tanks are often not regular; hot water is carried over from a previous day, which reduces the energy needed to heat it back up to the desired output temperature. The data used here is simply the water flow through the hot water system and the energy used to heat it, including standby losses in tanks and pipes.

Figure 15 shows the amount of water used per day on the X axis and the kWh used on that day on the Y axis, including standby losses in the tank and piping system, but not heat tape energy. A linear fit shows the relationship between kWh and gallons of hot water used. The slope of the lines are actually kWh per gallon of water heated. The slope indicates the efficiency of the system over all the days. The mean efficiency of all of the systems taken together is at least 0.05 kWh per gallon over the entire period of the study for the Addy, Montana, and Tacoma sites. For Portland, the blockage in its heat pump water supply distorted its efficiency until the issue climaxed and the system was repaired. The data analyzed in Figure 15 is only for the period when the Portland system operated as designed.

Ecotope reports that the long-term average performance of the unitary HPWHs in the field study is in the range of 0.1 kWh per gallon. This indicates that the average long-term field performance of the CO₂ refrigerant split system is more than twice as efficient as the current unitary systems tested in the Pacific Northwest.⁸

In addition, the split system takes all of its water heating energy from the outside air. At least some of the unitary systems take energy from the conditioned space they are in. This energy needs to be replaced during cold weather, which increases the difference in average performance between the two technologies.

The scatter shown in these plots is caused by the interaction of the HPWH operation and the water use by the household. These two factors combine to produce a measure of system efficiency, most accurately measured as close as possible to each hot water use. Figure 15 shows this energy and water use on a daily basis, but the heat pump does not operate every time hot water is used. Some days the heat pump does not operate at all because it filled the tank with hot water the night before.

⁸ The report may be found at this link: [Heat Pump Water Heater Model Validation Study, March 2015](#).

Figure 15. Water Flow through the Hot Water System and Energy Used to Heat It

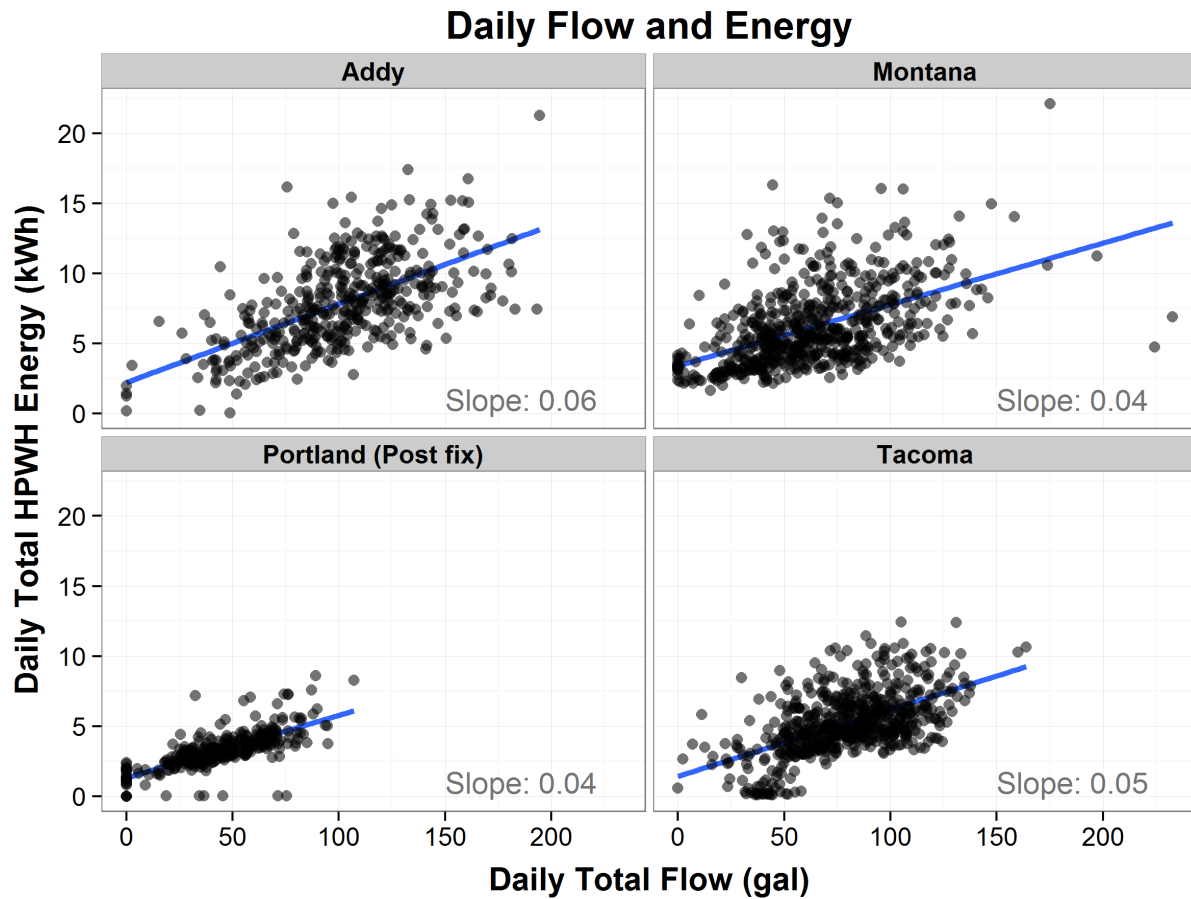
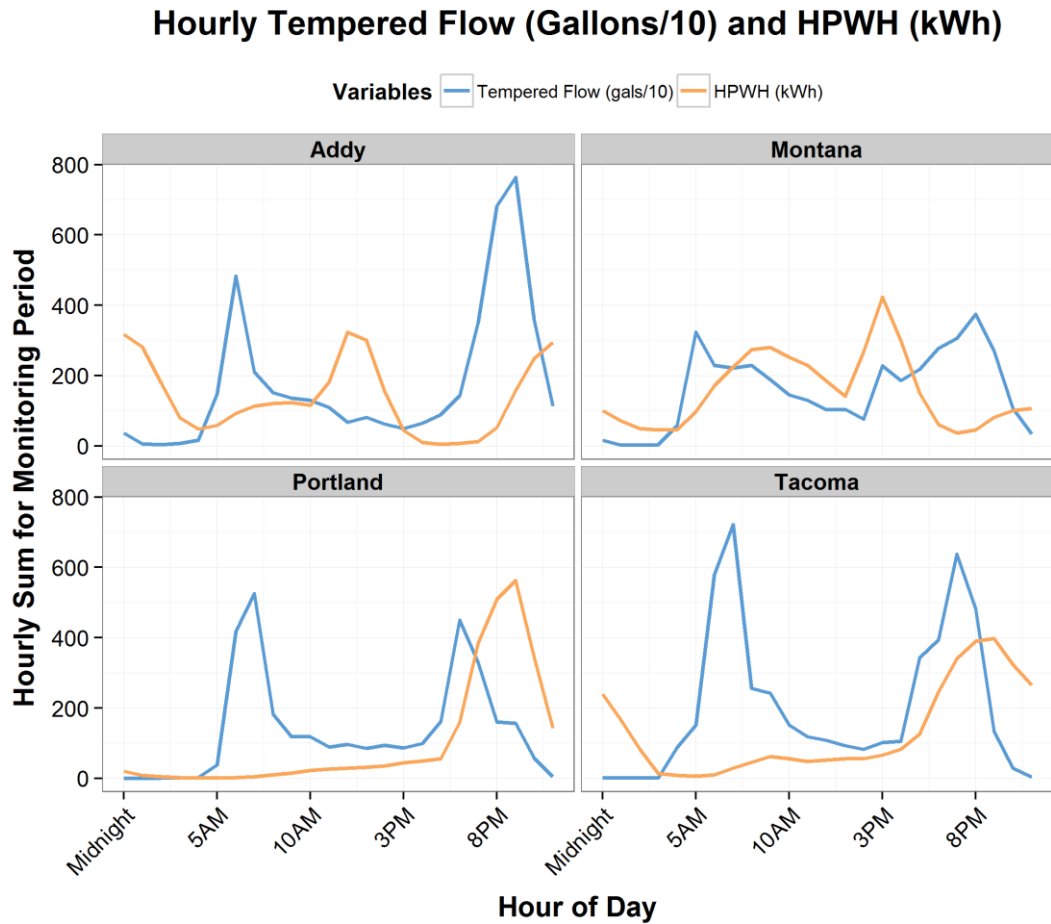

Figure 16 shows the hourly water use and HPWH energy use for each site over the entire study period. Most households are characterized by bimodal morning and evening water use, with Montana showing a less extreme morning/evening pattern and more midday usage. In the figure, the blue line is Tempered Flow; in order to show it on the same scale as HPWH sums, the gallons were divided by 10. HPWH (kWh) are shown by the orange line. The gallon readings are actually tenths of gallons and the kWh read on the same scale are the actual sum used at that time of day.

The HPWH energy profiles demonstrate that it is not uncommon for the HPWH cycle to occur many hours after peak household draws. Additionally, Tacoma's HPWH frequently cycled late in the day (after 8 p.m.), and it is likely that many times the HPWH cycle continued into the following day, displacing the consumed energy to the next day.

Figure 16. Hourly Water Use and HPWH Power Draw for Each Site



Montana Baseline Testing

At the Montana site, the backup water heater is the original 80-gallon tank. WSU had the tank re-plumbed with valves that divert the flow into either the HPWH or the ERWH tank so water flowing into one or the other tank goes through the flow meter and past the temperature sensors on the cold and hot water lines, as illustrated in **Figure 17**.

This allows direct comparison of the ERWH to the HPWH efficiency during the test period which is, of course, dependent on weather and water use. Tests consisted of switching to the ERWH for two weeks during winter, spring, and summer.

Figure 17. Water Flow Diversion into the HPWH or ER Tank – Montana Site

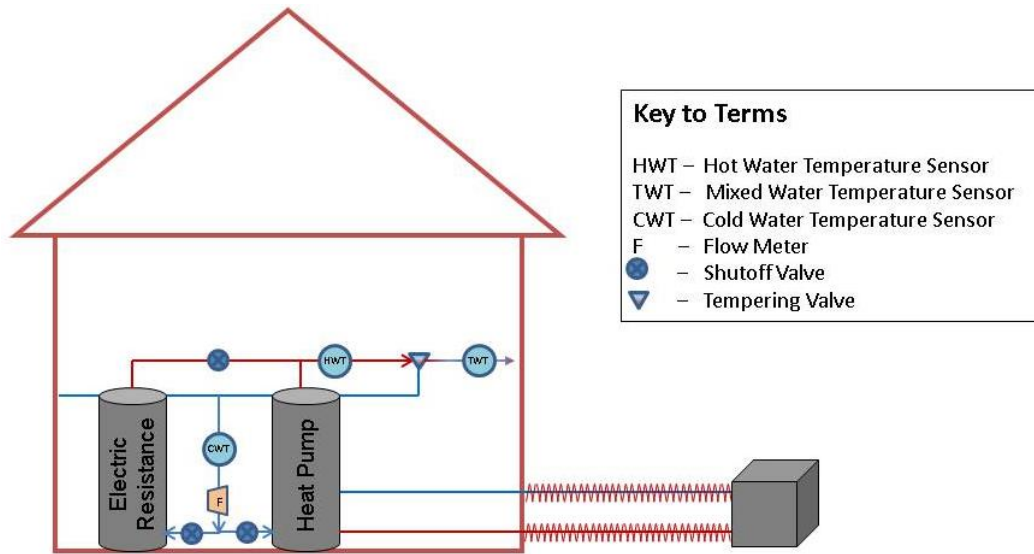

Table 6 shows the average electrical use per gallon for the HPWH versus the ERWH system in Montana. The kWh per gallon value was calculated for the ER baseline periods (which were typically 12 or 13 days in length) and periods of similar duration that immediately preceded each baseline test. The HPWH used approximately one-third to one-half of the energy consumed by the ERWH system depending on OAT.

Table 6. Average Electrical Usage per Gallon for the HPWH versus the ERWH in Montana

HPWH				
Row Labels	Count of Days	Average of daily HPWH kWh	Average of kWh/gal	Average of daily avg. OAT
PreTest1	13	8.8	0.09	35.1
PretTest2	12	6.4	0.07	54.2
PreTest3	13	4.2	0.08	68
ERWH				
Row Labels	Count of Days	Average of daily ERDHW kWh	Average of kWh/gal	Average of daily avg. OAT
Test1	13	17.64	0.19	38.1
Test 2	12	14.77	0.18	52.5
Test 3	13	8.29	0.20	70.9

Note that other factors, such as use, may impact the results, and these are snapshots. The long-term measurement of energy per gallon is more accurate, but these data support those findings.

The original analysis of the benchmark data showed ERWH efficiency greater than 1. Since this is impossible, both the power and water flow were examined by WSU and its contractor Ecotope. It was decided that the power data looked reasonable given the known capacity of the resistance elements, but the flow data showed an unexplained increase that could account for the error. The flow meter calibration was then tested through comparison with a microweir, which is a calibrated pitcher with holes that provides reasonably accurate measurements when used properly. The flow meter was found to report flow 25% greater than measured in the comparison test.

After this, flow was tested at two other sites where the flow was questioned: Tacoma and Portland. The Tacoma flow was found to be 10% greater and the Portland flow was found to be 5% less than reported. These flow adjustments were incorporated into the analysis, and all reported results contain these corrections.

Portland Line Clog and Impact on System Efficiency

The performance of the unit in Portland was significantly less efficient than the other three systems throughout the study, and in early 2015 it stopped working. The homeowner, with remote assistance from the manufacturer, found the issue was a clogged filter between the tank and the outdoor unit. He cleaned the filter on February 14, 2015 and the system has operated without issues since then. The source of the clog material appeared to be upstream of the new piping in the house. It could be debris from installation or debris pushed into the system through periodic system flushes conducted by the Portland water utility. This would explain why the clog seemed to increase over time.

Figure 18 compares the Portland system performance before and after the initial filter cleaning in February 2014. Subsequent to the repair, Portland had a slightly reduced value for the HPWH energy required to heat a gallon of water. Figure 18 compares the performance before and after the filter cleaning.

The Portland post-fix period also coincided with warming temperatures into the spring and summer. WSU kept monitoring the system into December 2015 in order to capture cold weather performance without the blockage. Unfortunately, the temperature of water returning from the outdoor unit increased again in December 2015, as shown in **Figure 10** on page 19. **Figure 19** is a photograph of the filter when it was checked on December 18, 2015. This clogged condition is evidently the cause of the temperature increases in the water returning from the outdoor unit.

The source of the clogging material was originally thought to be debris from installation. Given that it has recurred and the filter looked similar in both cases, the source is probably from the water system. It is recommended that the system be equipped with an alarm when clogging occurs and that a clear, easy-to-clean filter be installed on the system's cold water supply in areas with known clogging issues.

Figure 18. Portland System Performance Before and After Filter Cleaning

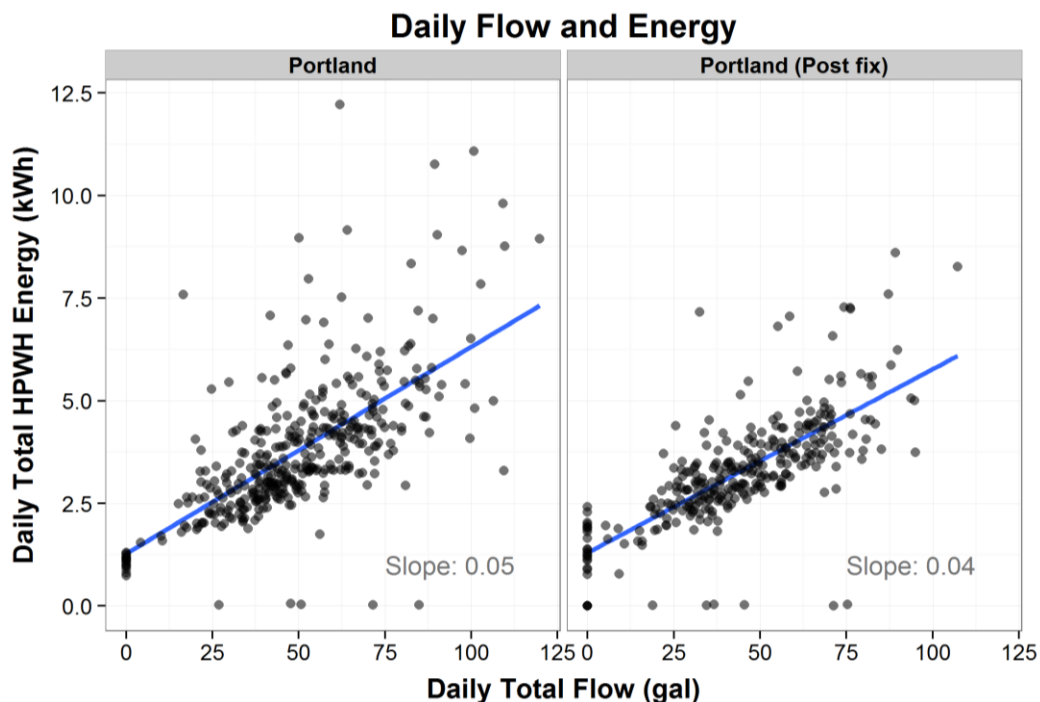

Figure 19. Clogged Filter at Portland Site



Multiple Regression Analysis

Numerous factors can impact performance, including the temperature of supply air, supply water, and the tank room; and the amount and the pattern of hot water used. When ascertaining the importance of a number of factors, a multiple regression analysis is an important tool. This analysis was performed by Ecotope with data prepared by WSU.

The factors examined by Michael Logsdon, Ecotope, include OAT, flow, temperature of the incoming water, and the field energy factor (FEF), which includes standby heat loss in tank and pipes.

One of the difficulties of assessing HPWH data is that performance can change based on subtle combinations of operating conditions. The FEF is heavily influenced by OAT and flow. Larger flow means that standby losses play a relatively smaller role and, hence, lead to higher overall efficiency. The Montana site had the lowest FEF, and the Tacoma site had the highest, but these results are plausible given the differing conditions.

A linear regression model was fit to the weekly FEF as a function of OAT, flow, and inlet water temperature with site-specific coefficients. The main benefit of this was to examine the regression residuals, which is loosely the FEF adjusted for operating conditions. Unusual occurrences become apparent by plotting regression residuals versus either the date or individual variables like OAT or flow. The only oddity found was in the Tacoma residuals plotted by date. The August 2014 flow change seems to correspond with an August 2014 FEF change. The approximately linear relationship between efficiency and operational variables was quite constant across the other sites.

Field Energy Factors

Performance is usually lower in the field than in the lab because it includes tank losses, line losses, and the impact of small water draws that pull hot water into the lines, where it cools. These factors reduce the system efficiency, so the WSU team proposed what it calls FEFs to differentiate them from EF and COP in the First Midterm Field Study Report. This concept was reviewed by BPA, and it was decided that it was a useful description of field performance. It could also be considered a whole-system COP.

Figure 20 shows the weekly FEF on the Y axis and the weekly average OAT on the X axis for data collected from system installation through October 31, 2014 for all sites. Generally, the trend is increased FEF as the OAT climbs. Note that during a week of very cold weather, with an average temperature of 10°F and lows dipping to almost -16°F, the Montana system kept running and supplied adequate volumes of heated water for a family of four. The FEF is only one, but this is better than the ERWH system it replaced, with an FEF of 0.7 to 0.8 due to line losses, draw profile, and tank losses.

Table 7 shows the average weekly FEF for each site. The FEFs for each site are displayed individually in **Figure 22**, at the end of this section. The scatter apparent in **Figure 20** is reduced when each site is graphed individually, as in **Figure 23**. In both the table and the plots, days with 0 FEF were eliminated prior to generating weekly summaries because these represented days when the house was unoccupied. The FEF plots do not coincide exactly with the efficiency plots in **Figure 15** meaning that the site with highest weekly field efficiencies (Tacoma) is not among the ones with lowest energy use per gallon (Montana and Portland). The only significant difference is that the FEFs are averaged over a week and then averaged overall, while the efficiencies are the slopes of the daily energy use per gallon.

Table 7. Average Weekly FEF for Each Site

Site	Average of Weekly FEFs
Addy	2.42
Montana	1.88
Portland (post fix)	2.30
Tacoma	2.83

The temperatures used in these plots for the Addy and Portland sites from installation to October 6, 2014 are hourly data from the National Weather Service substituted for the solar-induced high temperatures recorded at the sites up to fall 2014, when the problem was corrected.

Figure 20. Weekly FEF (Excluding Freeze Protection) and Temperature – All Sites

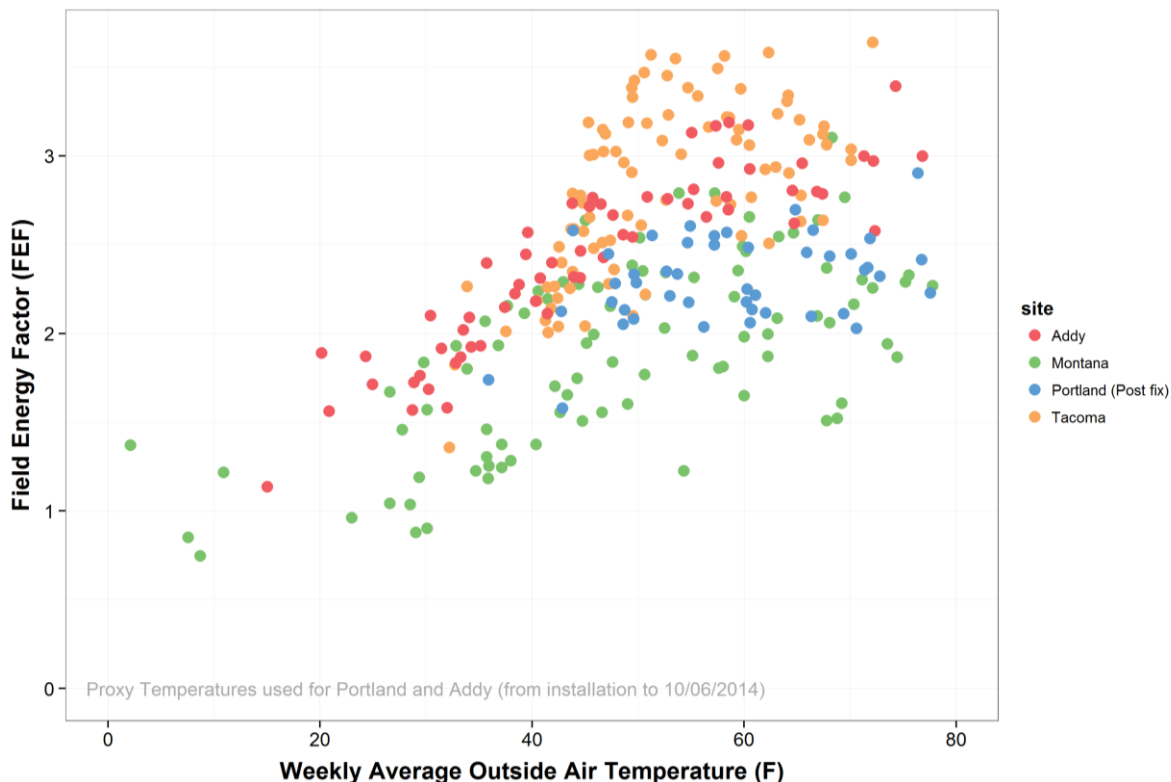

The EFs for the various test temperatures used in the lab were calculated. The results from the lab report are presented in **Figure 21**.

Figure 21. Energy Factor for Various Test Temperatures

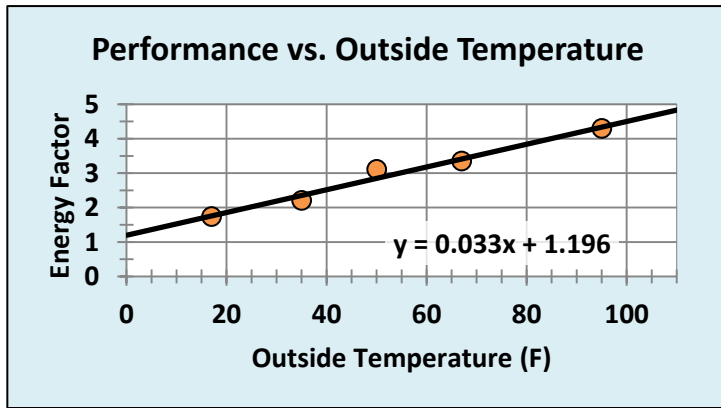

Figure 22 and **Figure 23** show the laboratory fit superimposed on the field results. Figure 22 also shows the Montana baseline test measurements in purple. Most of the weekly average FEF values fall below the laboratory model. This is expected because the EF has only tank losses subtracted from the heat produced. In the field, other energy expenses are added to the tank loss, including line losses and different draw volumes, sometimes less than the standard test pattern. These are added to the heat pump energy and impact all of the other factors.

Figure 22. Weekly FEF (Excluding Freeze Protection) and Temperature – All Sites with Lab Test Slope

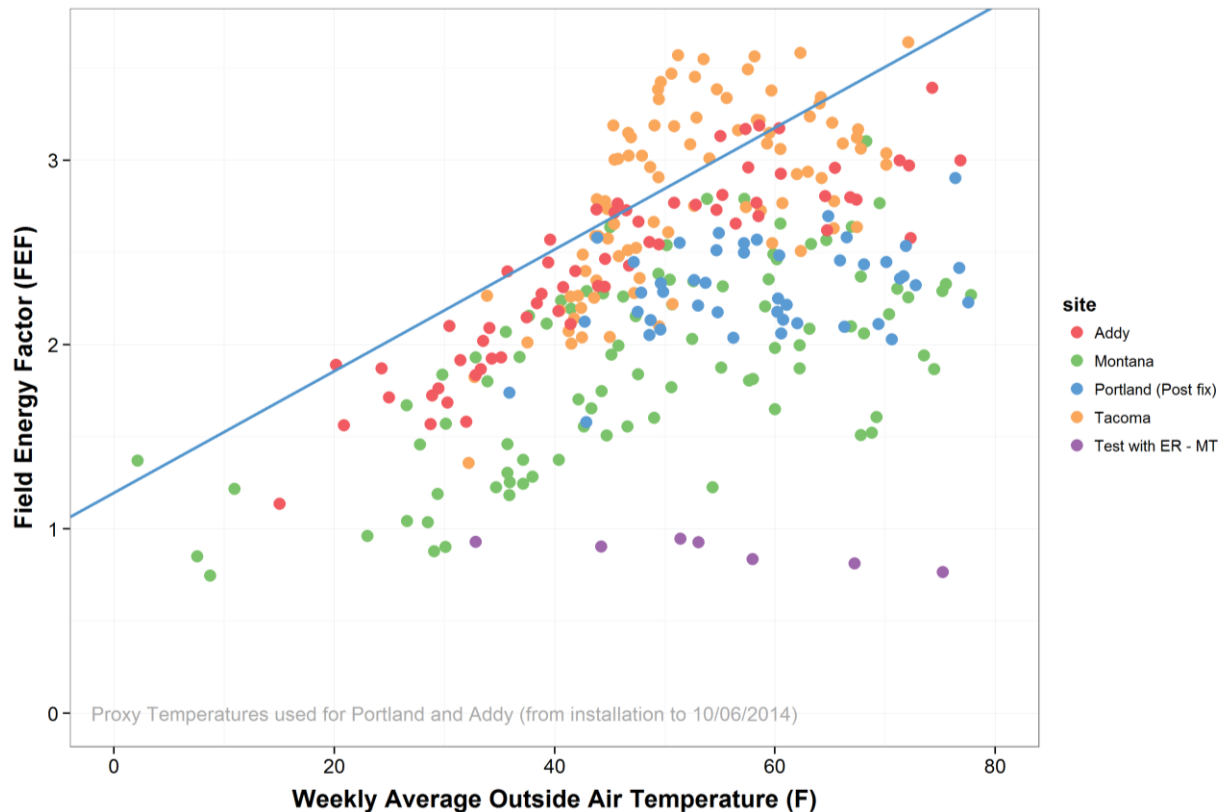
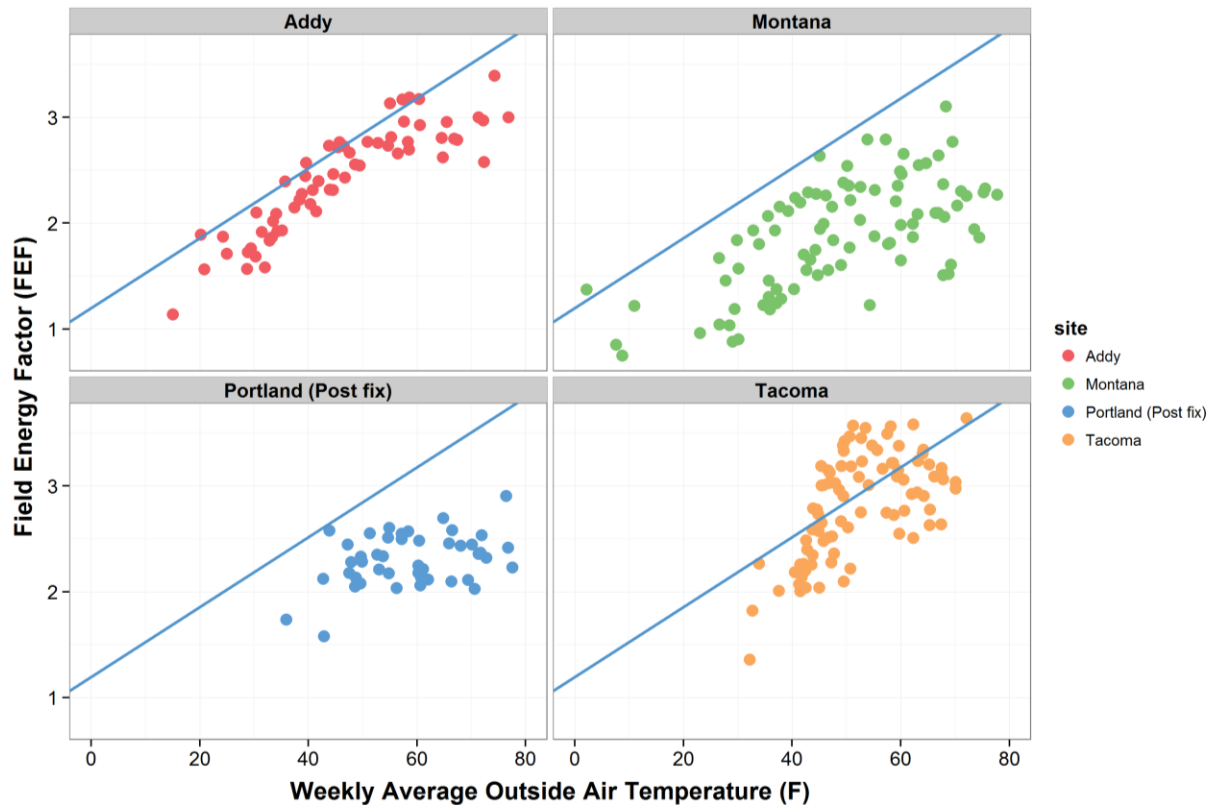

Figure 23. Weekly FEF (Excluding Freeze Protection and Temperature – per Site)



Even after adjustment, FEF values greater than the lab test slope occur. The excursion of FEFs above the slope of the lab tests correspond to increased flow measured at the Tacoma site beginning in August 2014. The flow change in Tacoma could not be explained by the homeowner. It is possible that it was an additional transient flow measurement problem, but because flow tests were only completed after equipment removal, and not intermittently during the study period, it is impossible to know this for certain and the increased flow and increased FEF period in Tacoma remain unexplained.

The lower overall performance in Portland is most likely a result of low hot water use. In the lab test report for TIP 302 on demand response performance of CO₂ HPWH, Ben Larson of Ecotope noted:

“Of further note are the seemingly low COPs for the lower occupancy households. This result is not unique to the Sanden HPWHs, but rather applies to all storage tank water heaters. The lower occupancies use far less water so much of the energy is spent heating the tank and then is lost to the surroundings without ever being used by the occupant.” (Larson and Kvaltine, 2015)

The Portland site actually used the lowest amount of hot water and, despite the lower efficiency, also used the lowest amount of electricity to heat it.

Benefit-to-Cost Analysis and Climate Change Impact

Sufficient data was collected through the project to estimate both the installed cost by an experienced installation team and the average annual savings of the technology. In addition, the relative impact of the refrigerants on the climate are known and can be factored into the equation using assumptions such as a carbon tax proposed by initiative in Washington.

The benefit-to-cost analysis is based on the following-field tested assumptions:

1. The retail cost of the system is \$2,815. This is with a 66-gallon stainless steel tank with a 15-year warranty. The manufacturer intends to offer options with lower prices.
2. The installation labor cost is \$500. This assumes the electrician and plumber are in house and experienced installers, installing three to four systems a day.
3. Parts includes piping, heat tape, pipe insulation, sensor wire, outdoor shut off, electrical wire, and stand for the outdoor unit = \$200 wholesale
4. Markup is \$500.
5. Deferred cost for ERWH is \$800 according to credit used by the Regional Technical Forum.

Total installed incremental cost is: \$3,400

The savings potential of the system is based on the following Pacific Northwest facts:

1. An average number of three people per household use 45 gallons of hot water per day
2. According to this research, the Sanden GAU split system uses 0.05 kWh per gallon (see page 24).

Total annual savings equals 2,436 kWh per year

Cost-Effectiveness for Efficiency Value Only

- Inputs
 - Savings: 2,436 kWh/yr
 - Life: 20 years
 - Capacity Reduction Value (3 kW) \$28.8 per year based on the 7th Power Plan⁹
 - Discount Rate 5%
- Outputs
 - If incremental equipment & install cost is ≤ \$3,400, benefit-to-cost ratio is 1
 - Current incremental cost for volume purchase and in-house installation ≈ \$3,200
 - Simple payback at 10[¢] per kWh is 12 years

Cost-Effectiveness Considerations

- The cost effectiveness shown is for efficiency value only
- Demand response (DR) value should be added to the efficiency value where the unit will be used for that purpose
- When climate change impact is monetized, that will also be added to the value as a non-energy benefit.

⁹ Chapter 1, Executive Summary, Seventh Northwest Conservation and Electric Power Plan. On page 1-8 the average cost per MWh with a credit for avoided transmission and distribution is \$18 and \$30 without.

DR value is available. A number of peaking plants have been built in the Pacific Northwest. The cost of operating them ranges from \$0.14 to \$0.219 per kWh (Hynes, 2009). The Seventh Power Plan states “A significant amount of this [Demand Response] potential, nearly 1,500 megawatts, is available at relatively low cost; less than \$25 per kilowatt of peak capacity per year” (Seventh Power Plan, pp. 1-10). The peak capacity of the Sanden is 3 kW. If only half the cost stated in the Seventh Plan is used, the annual DR value is \$37.50. Over 20 years the discounted DR value is \$460.

If \$460 of DR value is added to the efficiency value (and deducted from system cost), the incremental cost of the installed system is \$2,740, well below the threshold of cost-effectiveness.

Another value is the carbon reduction equivalency. **Figure 24** shows the relative Global Warming Potential of common refrigerants. Note that 1 pound of R-410a is equivalent to 1 ton of CO₂.

Figure 24. Relative Global Warming Potential of Common Refrigerants

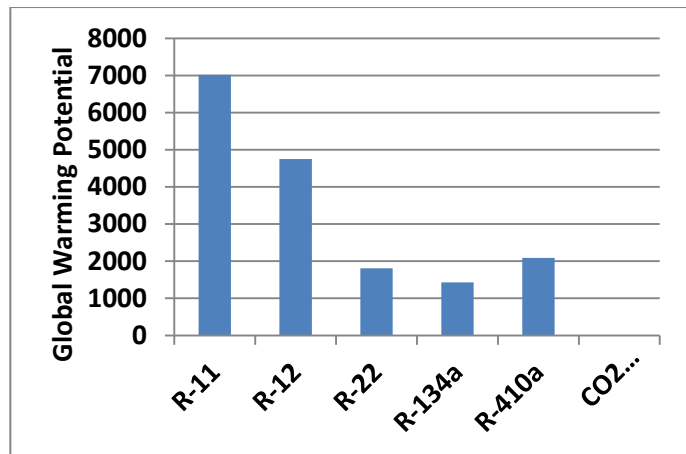

The CO₂ credit only works where the CO₂ refrigerant system replaces a HPWH using HFC refrigerant, because our model compares to an electric resistance water heater that does not use refrigerant. There are approximately 1.5 pounds of refrigerant in a typical HPWH. At some point, all

refrigerants will leak into the atmosphere. Using the 6th Power Plan assumption of \$47 per ton for CO₂, and the fact that it will probably lose its charge at least once during its 15-year life, the total CO₂ value of the HFC replacement by (ironically) CO₂ is \$141. Despite the higher incremental cost value of the HPWH, the savings increment is lower and the CO₂ credit would not be sufficient to make up the difference, but it would be a valuable additive to the DR value.

Conclusions

The lab and field test data on the Sanden GAU split system HPWH show these systems can provide the hot water needs of a family of up to seven without backup heat during a cold winter (with low temperatures ranging from almost -16°F in Montana, 2°F in Spokane, and the 20s°F in Portland and Tacoma).

The energy needed to heat water in the field study averaged approximately 0.05 kWh per gallon used. This is half the energy needed by standard unitary HPWHs according to recent analysis of a long-term field study done by Ecotope. At least some of these standard units took energy from interior space, so the actual performance benefits of the split-system are greater.

The efficiency plus a modest value for significant permanent capacity reduction make these CO₂ HPWH cost effective compared to an ERWH. When values for DR and climate benefit are included, the cost effectiveness increases.

The next step is commercialization. This project has helped and encouraged the manufacturer to pursue UL listing for the system studied in this research. The split system meeting all U.S. plumbing and electrical standards with advanced freeze protection and UL listing will soon be available for purchase at the price stated in the cost-effectiveness section.

Recommendations

1. The barriers to implementation of this technology are now institutional. The Pacific Northwest utility system can benefit greatly from this new technology, and it must promote this technology to move it into the mainstream. This section offers specific recommendations designed to help achieve this goal.
 - Provide formal Northern Climate Specification listing for the split system. Because of its efficiency, a new tier should be considered.
 - Expedite consideration of this technology by the Regional Technical Forum to provide a basis on which BPA and utilities can invest in it. This should include a valuation of capacity value.
 - Promote the technology through the regional HPWH marketing network. WSU stands ready to conduct training and assist in creation of fact-based marketing information.
 - BPA should encourage utilities to apply appropriate incentives to encourage adoption of this technology.

2. Freeze protection is needed for systems located in climates with the possibility of freezing water due to power outages. Heat tape and internal freeze protection cannot operate without electricity. It is recommended that units sold in any area with historic cold coupled with power failure be equipped with systems that can protect the outdoor unit from freezing. This includes very cold climates that can freeze a system in a matter of hours as well as areas like Puget Sound and the highlands of California and Appalachia where freezing conditions coupled with long term power losses can and have occurred.
 - The freeze protection should be automatic.
 - It should be standard equipment.

3. Systems to protect the system from clogging due to debris in the water supply and to alert the home owner when it does occur should be provided in areas where these conditions exist. The present system has a filter that requires guidance to access, and shuts the system down when flow becomes too restricted. This will necessitate a service call when it occurs for many users who will not know the cause or the solution.
 - In areas where tap aerators are routinely clogged by water system flushing or line maintenance, the filter in the outdoor unit is likely to become clogged.
 - A solution is to require installations in such areas to have a clear filter that is easily seen and cleaned by the home owner. The home owner should be informed why the filter is there and how to maintain it.

References

DOE, 1998. "Energy Conservation Program for Consumer Products: Uniform Test Method for Measuring the Energy Consumption of Water Heaters," *Federal Register*. U.S. Department of Energy, 10 CFR 430, May 11, 1998, Part 430, pp. 26008-26016. Retrieved from <http://energy.gov/eere/buildings/appliance-and-equipment-standards-program>

Ecotope and NEEA, 2015. *Heat Pump Water Heater Model Validation Study*, March 2, 2015. <http://neea.org/docs/default-source/reports/heat-pump-water-heater-saving-validation-study.pdf?sfvrsn=8>

Eklund, K.; Banks, A.; 2015. *Advanced Heat Pump Water Heater Research First Midterm Field Study Report*, October 30, 2014; updated March 19, 2015. <http://www.energy.wsu.edu/documents/FirstMidtermReportonMonitoringofAdvancedHPWHfromInstallationthruMarch2014-Final.pdf>

Fluid Market Strategies and NEEA, 2013. *Heat Pump Water Heater Field Study Report*. October 22, 2013. <http://neea.org/docs/default-source/reports/heat-pump-water-heater-field-study-report.pdf?sfvrsn=5>

Hynes, J., 2009. "How to Compare Power Generation Choices." *Renewable Energy World*, October 29, 2009. <http://www.renewableenergyworld.com/rea/news/article/2009/10/how-to-compare-power-generation-choices>

Larson, B.; Kvaltine, N.; 2015. *Laboratory Assessment of Demand Response Characteristics of Two CO₂ Heat Pump Water Heaters*, p. 31. September 30, 2015.

Larson, B., 2013. *Laboratory Assessment of Sanden GAU Heat Pump Water Heater Lab*. A Report of BPA Technology Innovation Project #292. Prepared by Ecotope, Inc. for the WSU Energy Program under contract to BPA. September 18, 2013. http://www.energy.wsu.edu/documents/Sanden_CO2_split_HWPH_lab_report_Final_Sept%202013.pdf

Logsdon, M., 2015. *Temperature-Energy Regression Models for Energy Use in Buildings*. GitHub repository. <https://github.com/EcotopeResearch/rterm>

Northwest Power and Conservation Council, 2015. *Seventh Power Plan*. The draft plan is available at: <https://www.nwcouncil.org/energy/powerplan/7/draftplan/>.